

Czech Technical University in Prague  
Faculty of Electrical Engineering  
Department of Telecommunication Engineering



**Coexistence of different optical systems and technologies  
on a common physical layer of optical transmission  
networks**

Master thesis

*Bc. Mikhail Nurov*

*Supervisor: Ing. Michal Lucki, Ph.D.*

Prague, May 2019

# Declaration

I hereby declare I have written this diploma thesis independently and quoted all the sources of information used in accordance with methodological instructions on ethical principles for writing an academic thesis. Moreover, I state that this thesis has neither been submitted nor accepted for any other degree.

In Prague, May 2019

.....  
Bc. Mikhail Nurov

## Čestné prohlášení

Prohlašuji, že jsem zadanou diplomovou práci zpracoval sám s přispěním vedoucího práce a konzultanta a používal jsem pouze literaturu v práci uvedenou. Dále prohlašuji, že nemám námitek proti půjčování nebo zveřejňování mé diplomové práce nebo její části se souhlasem katedry.

V Praze, 05.2019

.....  
Bc. Mikhail Nurov

# Poděkování

Mé poděkování patří panu Ing. Michalu Luckimu, PhD. za odborné vedení, za pomoc, vstřícnost při konzultacích a cenné rady při zpracování této práce. Děkuji také za pomoc při gramatické kontrole práce.



## I. OSOBNÍ A STUDIJNÍ ÚDAJE

Příjmení: **Nurov** Jméno: **Mikhail** Osobní číslo: **452963**  
Fakulta/ústav: **Fakulta elektrotechnická**  
Zadávající katedra/ústav: **Katedra telekomunikační techniky**  
Studijní program: **Elektronika a komunikace**  
Studijní obor: **Komunikační systémy a sítě**

## II. ÚDAJE K DIPLOMOVÉ PRÁCI

Název diplomové práce:

**Koexistence různých optických systémů a technologií na společné fyzické vrstvě optických přenosových sítí**

Název diplomové práce anglicky:

**Coexistence of Different Optical Systems and Technologies on a Common Physical Layer of Optical Transmission Networks**

Pokyny pro vypracování:

Cílem práce je studium možností současného provozování více optických systémů na společné fyzické vrstvě. Díleším cílem je porovnání možností provozování vybraných párů optických systémů na společném fyzickém médiu, jako jsou například systémy o rozdílných rychlostech (např. 10 Gbit/s a 100 Gbit/s), spektrech (např. širokospektrální jednonábový systém nebo CWDM versus DWDM), technologiích (např. DWDM PON a síť dlouhého dosahu), modulacích (např. amplitudová a fázová nebo mnohostavová). Dalším dílčím úkolem je parametrizace výsledků s ohledem (například) na výkonové úrovně, distribuci signálů v rozbočovačích, disperzi, dosah a další. Možným evaluačním kritériem je BER, dále také Q-faktor nebo SNR. Práce má simulační charakter, simulace provádějte metodou TDSS a u návrhu daného optického systému nebo sítě zohledňujte doporučení ITU-T v této oblasti. Finálním výsledkem jsou simulační balíky pro koexistenci různých optických systémů a konkrétní závěry o možnostech koexistence optických systémů, jejich slučování či efektivního nahrazování.

Seznam doporučené literatury:

- [1] Y. Hotta et al.: The demonstration of symmetric 10G-EPON system for coexistence with 1G-EPON, 2009 Conference on Optical Fiber Communication, San Diego, CA, USA, 2009.
- [2] H. Suzuki et al.: Simplified wavelength-tunable DWDM selector using removable driving circuit for coexistence-type WDM-PON, 2009 35th European Conference on Optical Communication, Vienna, Austria, 2009.
- [3] C. Li et al.: IEEE/OSA Journal of Optical Communications and Networking, Volume: 8, Issue: 11, 2016.
- [4] P. Munster et al.: Coexistence of access and backbone networks with sensor systems, 2016 International Workshop on Fiber Optics in Access Network (FOAN), Lisbon, Portugal, 2016.

Jméno a pracoviště vedoucí(ho) diplomové práce:

**Ing. Michal Lucki, Ph.D., katedra telekomunikační techniky FEL**

Jméno a pracoviště druhé(ho) vedoucí(ho) nebo konzultanta(ky) diplomové práce:

Datum zadání diplomové práce: **25.01.2019**

Termín odevzdání diplomové práce: \_\_\_\_\_

Platnost zadání diplomové práce: **20.09.2020**

Ing. Michal Lucki, Ph.D.  
podpis vedoucí(ho) práce

podpis vedoucí(ho) ústavu/katedry

přef. Ing. Pavel Ripka, CSc.  
podpis děkana(ky)

# Summary

Cílem práce je studium možností současného provozu různých optických systémů na společné fyzické vrstvě optických přenosových sítí. Tato práce se primárně zabývá porovnáním možností a omezení vybraných párů optických systémů na společné fyzické vrstvě, např. různé rychlosti systémů (10 Gbit / s a 80 Gbit / s), spektra (CWDM versus DWDM) a modulace (amplituda, fáze nebo víceosé). Koexistence různých systémů bude ukázána ve stejné fyzické vrstvě prezentované v simulačním softwaru Optsim. Výsledky simulace budou provedeny a porovnány pro nejvyšší úsilí o poměr BER(Bit Error Rate), Q- faktoru a poměru SNR(Signal-to-Noise-Ratio).

**Klíčová slova** WDM, CWDM, DWDM, Optsim, BER, Q-faktor, optické systémy, SNR, koexistence optických systémů

The aim of the thesis is to study the possibilities of simultaneous operations of different optical systems on a common physical layer of optical transmission networks. This thesis primarily deals with comparing the possibilities and limitations of selected pairs of optical systems on a common physical layer such as different speed systems (10 Gbit/s and 80 Gbit/s), spectral grid (CWDM versus DWDM) and modulations (amplitude, phase or multilevel). Coexistence of different systems will be shown at the same physical layer presented in Optsim simulation software. Simulation results will be performed and compared for the highest effort of Bit Error Ratio, Q-factor and Signal-to-noise-Ratio.

**Keywords:** WDM, CWDM, DWDM, Optsim, BER, Q-factor, optical systems, SNR, coexistence of optical systems

# List of Acronyms

<b>ACE</b>	Amplified Spontaneous Emission
<b>ADSL</b>	Asymmetric Digital Subscriber Line
<b>BER</b>	Bit Error Rate
<b>CW</b>	Continuous Wave
<b>CWDM</b>	Coarse Wavelength Density Multiplexing
<b>DPSK</b>	Differential Phase Shift Keying
<b>EDFA</b>	Erbium-Doped Fiber Amplifier
<b>G-PON</b>	Gigabit Passive Optical Network
<b>G-EPON</b>	Gigabit Ethernet Passive Optical Network
<b>QAM</b>	Quadrature Amplitude Modulation
<b>WDM</b>	Wavelength Density Multiplexing
<b>DWDM</b>	Dense Wavelength Density Multiplexing
<b>FWM</b>	Four-Wave Mixing
<b>GVD</b>	Group velocity dispersion
<b>ISI</b>	Intersymbol Interference
<b>NRZ-OOK</b>	Non-Return-to-Zero On-Off Keying
<b>NZDSF</b>	Non-Zero Disperse-Shifted Fiber
<b>OA</b>	Optical Amplifier
<b>OSNR</b>	Optical Signal-to-Noise Ratio
<b>PIN</b>	p-i-n photodiode
<b>PON</b>	Passive Optical Network
<b>QPSK</b>	Quadrature Phase-Shift Keying
<b>SPM</b>	Self-Phase Modulation
<b>SSMF</b>	Standard Single Mode Fiber
<b>TDSS</b>	Time Domain Split Step
<b>XPM</b>	Cross-Phase Modulation

# List of Tables

2.1	Comparing of CWDM and DWDM systems . . . . .	6
4.1	Standard Single Mode Fiber SSMF Parameters (SSMF)[19] . . . . .	14
4.2	Comparison NRZ-OOK DWDM outputs over 25/100 km . . . . .	18
4.3	Comparison DPSK DWDM outputs over 25/100 km . . . . .	21
4.4	Comparison QAM DWDM outputs over 25/100 km . . . . .	24
5.1	Performance of evaluation criteria of DPSK DWDM over NRZ-OOK CWDM system . . . . .	29
5.2	Performance of evaluation criteria of QAM DWDM over NRZ-OOK CWDM system . . . . .	32
5.3	Performance of evaluation criteria of NRZ-OOK DWDM over NRZ-OOK CWDM system . . . . .	34
5.4	Performance of evaluation criteria of NRZ-OOK and DPSK DWDM systems	38
5.5	Performance of evaluation criteria of QAM and DPSK DWDM systems . .	40
5.6	Performance of evaluation criteria of QAM and NRZ-OOK DWDM systems	42
5.7	Performance of evaluation criteria of DPSK and NRZ-OOK DWDM systems with safety band . . . . .	46
5.8	Performance of evaluation criteria of DPSK and NRZ-OOK DWDM systems with safety band . . . . .	48
5.9	Performance of evaluation criteria of QAM and NRZ-OOK DWDM systems with safe space . . . . .	51



# List of Figures

2.1	Conventional fiber attenuation versus wavelength. O- Original, E-Extended, S- Short, C-Conventional, L-Long band. [4][5][6][7] . . . . .	4
3.1	Eye diagram example with represented mean and standard deviations . . .	10
3.2	Relation between BER and Q-factor[10] . . . . .	11
3.3	Signal to noise level ratio . . . . .	12
3.4	Eye distortions caused by different impacts in an optical transmission line: a) back-to-back b) narrow-band filtering c) ASE-noise limitations d) GVD- limitation e) single channel nonlinearities f) multi-channel nonlinearities [9] . . . . .	13
4.1	Optical link composed of the same span . . . . .	14
4.2	NRZ-OOK transmitter . . . . .	15
4.3	16 channel NRZ-OOK DWDM topology . . . . .	16
4.4	Optical Spectrum of NRZ-OOK DWDM system. a)25 km b)100 km . . .	16
4.5	Eye diagrams NRZ-OOK channel 1. a)25 km b)100 km . . . . .	17
4.6	Eye diagrams NRZ-OOK channel 7. a)25 km b)100 km . . . . .	17
4.7	Eye diagrams NRZ-OOK channel 16. a)25 km b)100 km . . . . .	17
4.8	DPSK transmitter . . . . .	18
4.9	16 channel DPSK DWDM topology . . . . .	19
4.10	Optical spectrum of 16 channel DPSK DWDM system. 25 km distance . .	19
4.11	Optical spectrum of 16 channel DPSK DWDM system. 100 km distance .	20
4.12	Eye Diagrams DPSK over 25 km.a) Channel 1 b) Channel 7 c) Channel 16	20
4.13	Eye Diagrams DPSK over 100 km.a) Channel 1 b) Channel 7 c) Channel 16	20
4.14	QAM transmitter . . . . .	21
4.15	16 QAM DWDM system topology . . . . .	22
4.16	16 QAM DWDM system topology . . . . .	23
4.17	Eye Diagrams QAM over 25 km.a) Channel 16 b) Channel 7 c) Channel 1	23
4.18	Eye Diagrams QAM over 100 km.a) Channel 7 b) Channel 16 c) Channel 1	23
4.19	Comparison of Q-factor over 25 and 100 km . . . . .	25

5.1	16 channels DPSK over 7 channels NRZ-OOK topology . . . . .	27
5.2	16 DPSK DWDM over 7 NRZ-OOK CWDM optical spectrum . . . . .	28
5.3	Eye diagrams a) NRZ-OOK channel b) DPSK channel . . . . .	28
5.4	16 channels QAM over 7 channels NRZ-OOK topology . . . . .	30
5.5	16 QAM DWDM over 7 NRZ-OOK CWDM optical spectrum . . . . .	31
5.6	16 QAM DWDM optical spectrum . . . . .	31
5.7	Eye diagrams a) NRZ-OOK channel b) QAM channel . . . . .	32
5.8	16 channels NRZ-OOK over 7 channels NRZ-OOK topology . . . . .	33
5.9	16 NRZ-OOK DWDM over 7 NRZ-OOK CWDM optical spectrum . . . . .	33
5.10	Eye diagrams a) NRZ-OOK CWDM channel b) NRZ-OOK DWDM channel	34
5.11	Comparison of Q-factor of DWDM systems . . . . .	35
5.12	16 channels NRZ-OOK and 16 channels DPSK hybrid topology of DWDM system . . . . .	36
5.13	16 NRZ-OOK and 16 DPSK hybrid systems optical spectrum . . . . .	37
5.14	Eye diagrams a)channel 1 DPSK b)channel 7 DPSK c)channel 16 DPSK .	37
5.15	Eye diagrams a)channel 1 NRZ-OOK b)channel 7 NRZ-OOK c)channel 16 NRZ-OOK . . . . .	37
5.16	16 channels QAM and 16 channels DPSK hybrid topology of DWDM system	39
5.17	16 QAM and 16 DPSK hybrid systems optical spectrum . . . . .	39
5.18	Eye diagrams a)channel 1 DPSK b)channel 7 DPSK c)channel 16 DPSK .	40
5.19	Eye diagrams a)channel 1 QAM b)channel 7 QAM c)channel 16 QAM . . .	40
5.20	16 channels QAM and 16 channels NRZ-OOK hybrid topology of DWDM system . . . . .	41
5.21	16 QAM and 16 NRZ-OOK hybrid systems optical spectrum . . . . .	41
5.22	Eye diagrams a)channel 1 NRZ-OOK b)channel 7 NRZ-OOK c)channel 16 NRZ-OOK . . . . .	42
5.23	Eye diagrams a)channel 1 QAM b)channel 7 QAM c)channel 16 QAM . . .	42
5.24	Comparison of Q-factor of DWDM systems . . . . .	43
5.25	16 channels DPSK and 16 channels NRZ-OOK topology of spaced DWDM system . . . . .	44
5.26	16 QAM and 16 NRZ-OOK hybrid systems optical spectrum . . . . .	45
5.27	Eye diagrams a)channel 1 NRZ-OOK b)channel 7 NRZ-OOK c)channel 16 NRZ-OOK . . . . .	45
5.28	Eye diagrams a)channel 1 DPSK b)channel 7 DPSK c)channel 16 DPSK .	46
5.29	16 channels DPSK and 16 channels QAM topology of spaced DWDM system	47
5.30	16 QAM and 16 DPSK hybrid systems optical spectrum . . . . .	47
5.31	Eye diagrams a)channel 1 QAM b)channel 7 QAM c)channel 16 QAM . . .	48

5.32 Eye diagrams a)channel 1 DPSK b)channel 7 DPSK c)channel 16 DPSK . . . 48

5.33 16 channels NRZ-OOK and 16 channels QAM topology of spaced DWDM system . . . . . 49

5.34 16 QAM and 16 NRZ-OOK hybrid systems optical spectrum . . . . . 50

5.35 Eye diagrams a)channel 1 QAM b)channel 7 QAM c)channel 16 QAM . . . 50

5.36 Eye diagrams a)channel 1 NRZ-OOK b)channel 7 NRZ-OOK c)channel 16 NRZ-OOK . . . . . 50

5.37 Comparison of Q-factor of DWDM systems . . . . . 51

# Contents

<b>Poděkování</b>	<b>iii</b>
<b>Summary</b>	<b>vi</b>
<b>List of Acronyms</b>	<b>vii</b>
<b>List of Tables</b>	<b>viii</b>
<b>List of Figures</b>	<b>ix</b>
<b>1 Introduction</b>	<b>1</b>
1.1 Problem statement . . . . .	1
1.2 Thesis arrangement . . . . .	2
<b>2 WDM systems issues</b>	<b>3</b>
2.1 Wavelength Division Multiplexing . . . . .	3
2.1.1 Coarse WDM (CWDM) . . . . .	4
2.1.2 Dense WDM (DWDM) . . . . .	5
2.1.3 Comparing two WDM systems . . . . .	6
2.2 Nonlinear processes . . . . .	7
2.2.1 Self-phase modulation . . . . .	7
2.2.2 Cross-phase modulation (XPM) . . . . .	7
2.2.3 Four-Wave Mixing . . . . .	7
<b>3 Monitors</b>	<b>9</b>
3.1 Optsim . . . . .	9
3.2 Bit Error Rate (BER) . . . . .	9
3.3 Q-factor . . . . .	10
3.4 Optical signal-to-noise ratio (OSNR) . . . . .	11
3.5 Eye diagram . . . . .	12

<b>4</b>	<b>Modulations</b>	<b>14</b>
4.1	Standard Single Mode Fiber . . . . .	14
4.2	Non-Return-to-Zero On-Off shift keying (NRZ-OOK) . . . . .	15
4.3	Differential Phase-shift Keying (DPSK) . . . . .	18
4.4	Quadrature amplitude modulation (QAM) . . . . .	21
4.5	Consequences . . . . .	24
<b>5</b>	<b>Results</b>	<b>26</b>
5.1	DWDM over CWDM . . . . .	26
5.1.1	DPSK over NRZ-OOK . . . . .	27
5.1.2	QAM over NRZ-OOK . . . . .	29
5.1.3	NRZ-OOK over NRZ-OOK . . . . .	32
5.1.4	Consequences . . . . .	34
5.2	DWDM/DWDM implemented . . . . .	35
5.2.1	DPSK/NRZ-OOK . . . . .	36
5.2.2	DPSK/QAM . . . . .	38
5.2.3	QAM/NRZ-OOK . . . . .	40
5.2.4	Consequences . . . . .	43
5.3	DWDM/DWDM with safety band . . . . .	43
5.3.1	DPSK/NRZ-OOK . . . . .	44
5.3.2	DPSK/QAM . . . . .	46
5.3.3	QAM/NRZ-OOK . . . . .	49
5.3.4	Consequences . . . . .	51
<b>6</b>	<b>Conclusion</b>	<b>53</b>
<b>7</b>	<b>References</b>	<b>55</b>

# Chapter 1

## Introduction

In the modern world of high technologies, it is impossible to imagine that a person does not use information and communication networks. Serving the ordinary needs becomes faster and better every decade. Now high data transfer rate is one of the general priorities for the development of communication networks, which ultimately led to the emergence and extensive development of optical systems. The ability to transfer hundreds and thousands of gigabits of information per second over long distances is one of the most promising areas of the latest technologies. This is the foundation of technological development in the future. Nowadays, optical systems have firmly taken their place among the serving mass technologies. It is impossible to imagine the modern world without it. Along with the building of global communication networks, optical fiber is widely used in local area networks. Currently, optical networks are the most promising medium for transmitting information, as well as the most promising medium for transmitting large streams of information over substantial distances. This statement follows from the following features of optical systems

1. The transmission rates of fiber-optic systems are incredibly high.
2. Very low attenuation of the light signal in the optical fiber (compared to other media)
3. Optical fibers are made of quartz, the base of which is silicon dioxide, which makes this material much cheaper than, for example, copper.
4. Optical communication systems are resistant to electromagnetic interference, and the transmitted information is protected from unauthorized access.

### 1.1 Problem statement

Primary goal of the thesis is the study of behavior of WDM systems with different use of the optical spectrum. The aim of this thesis is also to compare the influence of systems

on each other, which may affect the choice of one or several options for the use of optical systems for different purposes. The advantages and limitations of the WDM systems that will be shown in this work can help in the calculation and planning the real optical communications.

## 1.2 Thesis arrangement

First chapters of this work focus on existing standards for the use of WDM systems and nonlinearities, which show the advantages and disadvantages of each of the systems. In general, this chapter covers such parameters as BER, Q-factor, OSNR, the advantages of certain CWDM and DWDM parameters: possible optical spectrum, maximum distance, maximum transmission rate etc.

the third chapter presents the three modulations that were chosen for further tests. Each of the modulations is a special way of transmitting information via an optical transmission line. To analyze the coexistence of the presented modulations in this chapter, the optical system was simulated with each of the modulations separately. The fourth chapter examines the CWDM and DWDM systems. The initial data taken from the previous chapters are the basis for a broad study of the coexistence of two systems on one physical layer.

The conclusions of the work include an attempt to find the best use of selected modulations in the use of coexisting optical systems of various types.

# Chapter 2

## WDM systems issues

### 2.1 Wavelength Division Multiplexing

At present, various optical networks are widely used, from G-PON and G-EPON , which are already outdated, to new-generation optical networks [28], allowing data transmission rates of hundreds of gigabits per second. Next generations of the PON systems increase the network capacity mostly by increasing the bit rate transmission. Despite these evident advantage, implementation of the next generation PON systems into practice should have been primarily be cost-effective [5]. Due to high bit rates and cost-efficiency, Wavelength Division Multiplexing technology has become increasingly popular. Coexistence types WDM and PON began to appear. Many of them were soon replaced by WDM technologies because of the already defined advantages. At the present time, the improvement of WDM systems and their possible limits are an actual problem. [8]

Wavelength Division Multiplexing (WDM) allows different data streams to be sent simultaneously over a single optical fiber network. WDM technology uses infrared light between 1260nm and 1670nm wavelengths [1][2], which are beyond the visible light spectrum. Most fibers are optimized for the two regions 1310nm and 1550nm, which allow for effective “windows” for optical networking. Wavelength Division Multiplexing (WDM) is a technology that puts data from different sources together on an optical fiber channel and with each signal carried at the same time on its own separate light wavelength. There are two main types of WDM technologies used today: Coarse Wavelength Division Multiplexing (CWDM) and Dense Wavelength Division Multiplexing (DWDM). The main difference between CWDM and DWDM technologies lies in how the transmission channels are spaced along the electromagnetic spectrum. CWDM and DWDM increase the amount of traffic that can be connected through an optic fiber. For longer distances CWDM is restricted to 9 working channels due to a chemical property in the fiber called the water peak, that is defined in ITU-T G.652[4].



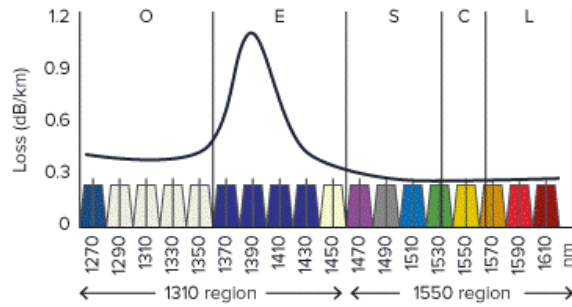

Figure 2.1: Conventional fiber attenuation versus wavelength. O- Original, E-Extended, S- Short, C-Conventional, L-Long band. [4][5][6][7]

Signal loss is 1.0dB/km in water peak region as opposed to 0.25dB/km in the 1550. DWDM channels lies mostly in the 1550nm region of the fiber because this area in the fiber has the lowest loss. [4]

### 2.1.1 Coarse WDM (CWDM)

CWDM is a wavelength multiplexing technology defined ITU-T Rec. G.671.2 [1]. Transmission is realized using max. 18 channels with central wavelengths between 1271 nm and 1611 nm for spacing of 20nm is required because of the wavelength dependence of the wavelength on the temperature (low-quality design and inexpensive radiation sources for the access network), which may vary considerably depending on the ambient temperature. For single-mode fiber 9/125  $\mu\text{m}$  max.18 channels are defined in the following bands: O - Original 1260 - 1360 nm (channels 1 to 5)

E - Extended 1360 - 1460 nm (channels 6 to 10) - usable for fibers with suppressed maximum attenuation due to OH ions

S - Short 1460 - 1540 nm (channels 11 to 14)

C - Conventional 1540 - 1560 (Channel 15)

L - Long 1560 - 1620 nm (channels 16 to 18)

Usually, channels 2 to 5 are used, at higher distances and attenuations, channels 14 to 17 are used. The interface for CWDM specifies ITU-T Recommendation G.695[2]. The interfaces are adapted to various network designs, topology and fiber type [6].

There are some advantages and disadvantages of CWDM system [27]:

Advantages

1. Improves the utilization of optical fiber resources compared to outdated PON systems.

2. Less optical losses and high mechanical sensitivity.

3. Good ratio of bit rate and cost.

Disadvantages

1. Used for short distances.
2. Big spacing compared to DWDM.
3. A small number of channels.

### 2.1.2 Dense WDM (DWDM)

The “dense” here means that the wavelength channels are very close to each other. DWDM separate wavelengths or channels of data are multiplexed into a channel transmitted on a single optical fiber. One DWDM system requires complex calculations of balance of power per channel, which is complicated when channels are added or removed.

For channel spacing of 12.5 GHz on a fiber, the allowed channel frequencies (in THz) are defined

$$193.1 + n \times 0.0125 \quad (2.1)$$

Where n is a integer including 0

For channel spacing of 25 GHz on a fiber, the allowed channel frequencies (in THz) are defined

$$193.1 + n \times 0.025 \quad (2.2)$$

Where n is a integer including 0

For channel spacings of 50 GHz on a fiber, the allowed channel frequencies (in THz) are defined

$$193.1 + n \times 0.05 \quad (2.3)$$

Where n is a integer including 0 For channel spacing of 100 GHz or more on a fiber, the allowed channel frequencies (in THz) are defined

$$193.1 + n \times 0.1 \quad (2.4)$$

Where n is a integer including 0.[3]

C-band: the wavelength range of 1530–1565 nm. If one channel is 100 GHz wide, then up to 40 optical channels can be combined, if its 50 GHz width is up to 80 channels;

L-band: the wavelength range of 1570–1605 nm. With a channel width of 50 GHz, up to 160 optical channels can be combined

DWDM system has its own advantages and disadvantages that should be taken into account when using this technology[26]

Advantages:

1. Works great over long distances.
2. Continuous data regeneration is not required.

3. High reliability and data transparency.

Disadvantages:

1. The use of power amplifiers leads to high prices.
2. Strong influence of dispersions
3. Attenuation loss due to impurities in core or cladding of fiber.

DWDM systems with close channel spacing are affected by many non-linear phenomena that are studied in this paper. Also, to control the behavior of DWDM systems, many factors need to be taken into account: the temperature of the laser diode, the appearance of non-linear and linear phenomena during close channel spacing, the use of a suitable optical fiber, control of the optical filter bandwidth, the use of wavelegth bands recommended for DWDM systems, etc.

### 2.1.3 Comparing two WDM systems

There are several differences between DWDM and CWDM systems. CWDM systems are used as a "light" version of WDM system and cannot fit as many data streams. CWDM systems, however, are also less expensive from the outset. The design, function and purpose also differ in terms of transmission length and distance [29]. WDM systems can fit more than 40 different data streams in the same amount of fiber used for two data streams in a CWDM system. CWDM systems were invented prior to DWDM systems mostly because the cost of cabling. Now that cabling and transmittal has become more affordable, DWDM systems are often used in place of CWDM systems. From the following table, you may get a clearer understanding:

Table 2.1: Comparing of CWDM and DWDM systems

Technology	CWDM	DWDM
Channels per optic fiber	Up to 16	Up to 88
Capacity per wavelength	Up to 10 Gbit/s	>100 Gbit/s
Channel spacing	20 nm	<10 nm
Distance	over 120 km	>1000 km
Cost	Low	High
Bands	O,E,S,C,L	C,L,S

The limits and advantages of possible ways to configure DWDM systems remain unexplored. Many features that affect the stable operation of DWDM systems, as well as the coexistence of CWDM and DWDM systems, have many possible ways to implement and solve. The study of these issues is one of the promising subjects in the research and improvement of optical systems.

## 2.2 Nonlinear processes

### 2.2.1 Self-phase modulation

Self-phase modulation (SPM) is one of the nonlinear limitations causes a nonlinear phase delay which has similar shape as the optical intensity in optical fibers.[15] SPM gives rise to phase modulation of the optical signal [11]. Briefly, SPM can be defined as a nonlinear change in the refractive index  $n$ :

$$\Delta n = 2n_2 I \quad (2.5)$$

Where  $n_2$  is the nonlinear index and  $I$  is the optical intensity .

### 2.2.2 Cross-phase modulation (XPM)

Cross-phase modulation is the change in the optical phase of a light beam caused by the interaction with another beam in a nonlinear medium. This can be described as a change in the refractive index:

$$\Delta n^{(2)} = 2n_2 I^{(1)} \quad (2.6)$$

Where  $n^{(2)}$  is the nonlinear index,  $I^{(1)}$  – the intensity of beam 1, which causes a refractive index  $n_2$  of beam 2 [30]

### 2.2.3 Four-Wave Mixing

Four wave mixing (FWM) produces additional optical frequency components in DWDM systems, where its channels are spaced closely to each another. FWM occurs when two or more waves of near frequencies are launched into a fiber, exciting a new wavelength, known as an idler. It is one of the most significant non-linear effect because of the large influence on transmitted signal.

As it excellently defined[11], Four-wave mixing (FWM) is a parametric process in which some different frequencies interact and by mixing generate additional spectral components

$$f_{add} = f_1 + f_2 - f_3 \quad (2.7)$$

Where  $f_{add}$  – new spectral component,  $f_1, f_2, f_3$  – original frequency components

For “good” suppression of FWM is recommended to use channel spacing according to

ITU-T recommendations. Too small channel spacing can excite FWM products. High power of laser sources and amplifiers have farther influence to FWM appearance. For suppression of FWM also is recommended to use non-zero dispersion shifted fibers. In this work I try to avoid non-linear parametric processes, which could affect results.

# Chapter 3

## Monitors

### 3.1 Optsim

This work is based on estimating system parameters such as optical signal to noise ratio (OSNR), Q-factor, bit error rate (BER) and uses the methods that are included in RSoft Design Group OptSim software. This software allows you getting accurate results, which includes the calculation of complex systems of differential equations, which include optical and electrical noise, as well as linear and nonlinear effects. This software uses the Time Domain Split Step (TDSS) method to simulate linear and nonlinear optical and electrical behavior component. This method is used to model fiber propagation equations:

$$\frac{\delta A(t, z)}{\delta z} = (L + N)A(t, z) \quad (3.1)$$

Where  $A(t, z)$  is the optical field,  $L$  – linear operator that stands for dispersion and other linear effects,  $N$  – operator that is responsible for all nonlinear effects. The idea is to calculate the equation over small spans  $\delta z$  of fiber by including either linear or nonlinear operator. [20]

OptSim library includes core optical components and prebuilt and predefined models: optical transmitters with different modulation formats, optical receivers, optical amplifiers, transmission fibers with preset parameters according to ITU-T recommendation, etc. Also it is possible to build required model from basic optical blocks.

### 3.2 Bit Error Rate (BER)

Bit Error Rate, BER is used as an important parameter that characterized the performance of data channels. When transmitting data from one point to another, either over a radio/ wireless link or a wired telecommunications link, the key parameter is how many

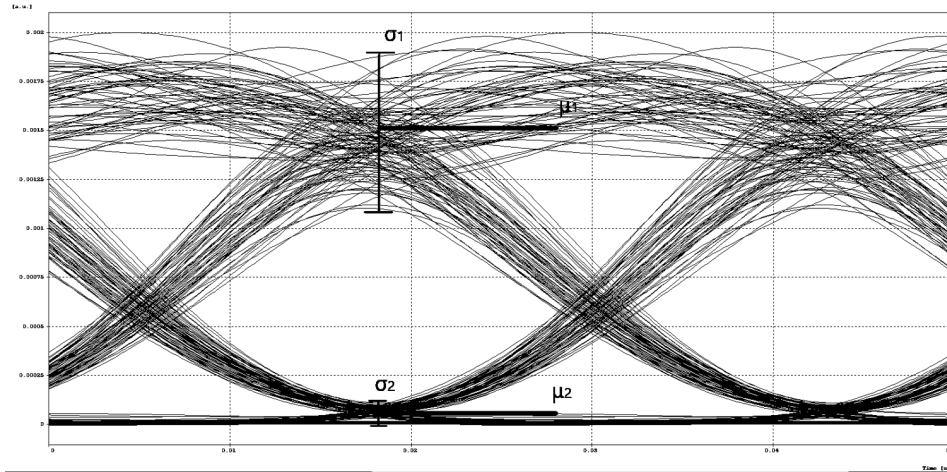

Figure 3.1: Eye diagram example with represented mean and standard deviations

errors will appear in the data that appears at the receiver. Bit Error Rate (BER) is applicable to everything from fiber optic links, to ADSL, Wi-Fi, cellular communications, IoT links and many more. Bit error rate is defined as the rate at which errors occur in a transmission system. This can be directly translated into the number of errors that occur in a string of a stated number of bits. The definition of bit error rate can be translated into a simple formula: [10]

$$N_{Errors}/N_{Bits} \quad (3.2)$$

Where  $N_{Errors}$  is the number of bit errors.  $N_{Bits}$  is the total number of transferred bits

### 3.3 Q-factor

The Q-factor measurement for the performance evaluation of optical transmission systems is defined by:

$$Q = \frac{|\mu_2 - \mu_1|}{\sigma_2 - \sigma_1} \quad (3.3)$$

where  $\mu_1$ ,  $\mu_0$  are the mean deviations of marks and zeros and  $\sigma_1$ ,  $\sigma_0$  are the standard deviations of marks and zeros.[10] Visual example is shown in Fig.(4.1) below.

Also Q-factor is defined as a function of the optimum decision threshold ( $I_D$ ) and expressed by:

$$Q = \frac{I_D - \mu_1}{\sigma_1} \quad (3.4)$$

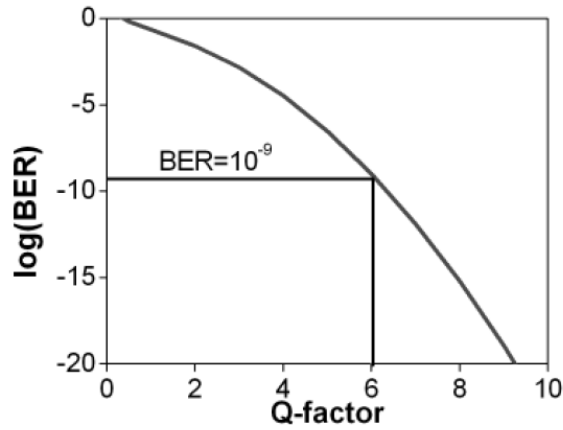

Figure 3.2: Relation between BER and Q-factor[10]

Where

$$I_D = \frac{\sigma_1\mu_2 + \sigma_2\mu_1}{\sigma_1 + \sigma_2} \quad (3.5)$$

The Q-factor evaluation enables a good BER estimation, but according to the inaccuracy of Gaussian distribution the predicted BER rate are mostly larger than the minimum expected BER.

According to Fig. 4.2, a Q-factor of 6 corresponds to a  $BER=10^{-9}$ . For a correct Q-factor calculation in next chapters, the minimum number of simulated bits will be determined through multiple calculations of Q with increasing lengths of bit sequences or with calculation neighboring channels in follow.

### 3.4 Optical signal-to-noise ratio (OSNR)

The Optical Signal-to-Noise Ratio (OSNR) is one of the most important criterion which represents the characterization of system efficiency in optical transmission lines [11]. The OSNR is simply defined as rate of the signal to noise power in an optical channel:

$$OSNR = \frac{P_S}{P_N} \quad (3.6)$$

Where ( $P_S$ ) is a signal power value, ( $P_N$ ) is a noise power value

The OSNR value is generally depends on amplifier infrastructure used on the receiver



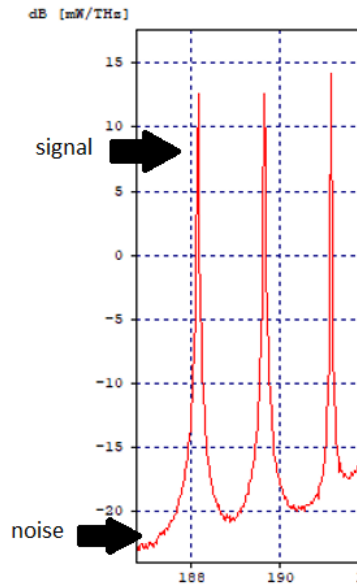

Figure 3.3: Signal to noise level ratio

side and it can be calculated by measuring the signal power as the difference between the total power of the signal peak and the quantity of the background noise. The background noise is measured by determining the noise contributions on either side of the signal peak. It is hard to realize in practise, because the noise power in an optical channel is included in the signal power. In a WDM systems the noise power calculating can be measured by interpolating the noise power between the neighboring channels[14]

### 3.5 Eye diagram

The evaluation criteria such as BER, Q-factor, and OSNR do not directly identify origins of system impairments. An eye diagram is created by the superposition of detected/received bits. It is a good way to reveal some of the negative influences of the system.

The eye diagram is a useful tool for the characterization of the optical transmission. characteristics of the signal eye are strongly depended on different limitations. For example, high narrow-band filtering of the optical channel causes a broadening of the single pulses and results in ISI-effects between the bits. The amplified spontaneous emission (ASE)-noise value depends on the signal extinction ratio, stronger signal level fluctuations in marks than in spaces. The accumulation of chromatic dispersion during the transmission causes a pulse broadening resulting in variations of the signal levels, and as a result the overlapping occurs between neighboring pulses. The interaction between linear group velocity dispersion (GVD) and nonlinear effects self-phase modulation (SPM)

is reflected in the symmetrical fluctuations of the signal power at the rising and trailing edges of the signal. The analysis of the eye diagrams makes able a selective characterization and selective tuning of different transmission limitations. There are some kinds of different negative impacts [9]

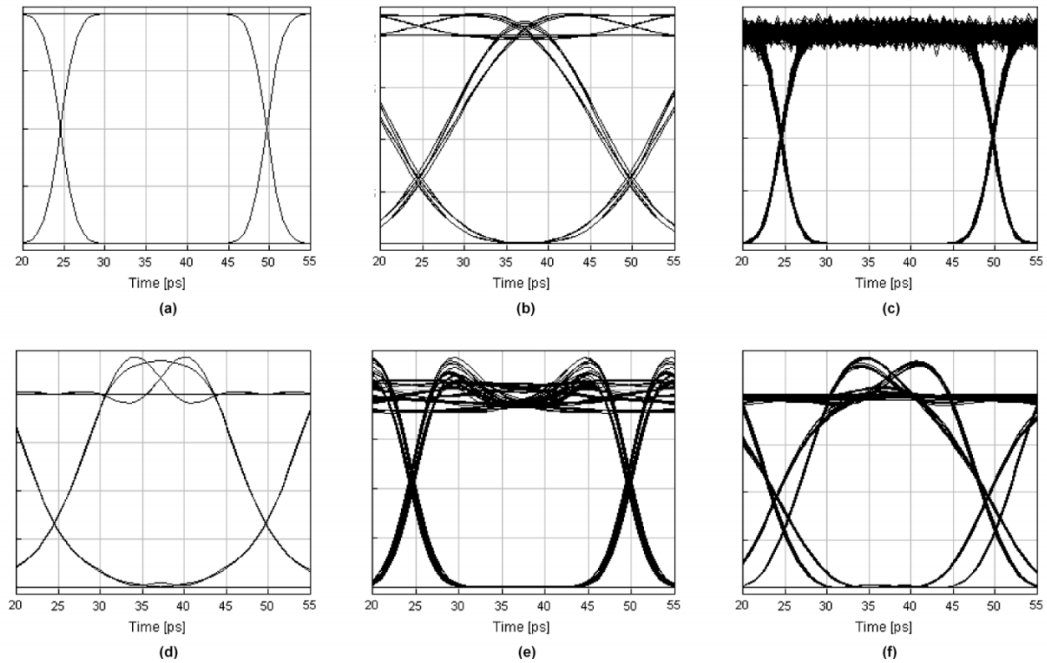

Figure 3.4: Eye distortions caused by different impacts in an optical transmission line: a) back-to-back b) narrow-band filtering c) ASE-noise limitations d) GVD-limitation e) single channel nonlinearities f) multi-channel nonlinearities [9]

# Chapter 4

## Modulations

### 4.1 Standard Single Mode Fiber

In this work all tests will be conducted over Standard Single Mode Fiber (SSMF).SSMF fibers, which are described in ITU-T Recommendation G.652D [4], with a reduced water peak for spectrum operation are optimized. It allows them to be used in the optical system's wavelength region between 1310 nm and 1550 nm. It is a suitable configuration to support Coarse Wavelength Division Multiplexed (CWDM) and Dense Wavelength Division Multiplexed (DWDM) transmission. The fiber construction in Optsim software is presented as a composed block, which included the fiber, an inline Optical Amplifier (OA) and a fiber grating.

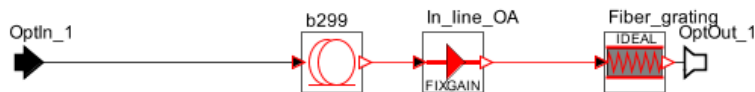

Figure 4.1: Optical link composed of the same span

Table 4.1: Standard Single Mode Fiber SSMF Parameters (SSMF)[19]

Attenuation [ $\text{dB} \cdot \text{km}^{-1}$ ]	0.19
Fiber Dispersion [ $\text{ps} \cdot \text{nm}^{-1} \cdot \text{km}^{-1}$ ]	16
Polarization Mode Dispersion (PMD) coefficient [ $\text{ps} \cdot \text{km}^{-1/2}$ ]	0.1
Slope of dispersion curve [ $\text{ps} \cdot \text{nm}^{-2} \cdot \text{km}^{-1}$ ]	0.07

## 4.2 Non-Return-to-Zero On-Off shift keying (NRZ-OOK)

Non-Return-to Zero On-Off shift keying is a type of the intensity modulation belonging to the amplitude shift keying (ASK) modulation format. Binary information is represented by the presence or absence of an optical signal. The decision level compensates the probability of the error log 0 and log 1 and is dependent on the received power and noise. This modulation is most popular used in optic systems. NRZ-OOK is high resistant to nonlinearity on the laser and the external modulator. That's why this modulation used as a base of plenty of systems defined in ITU-T Recommendation for DWDM systems [16][17]

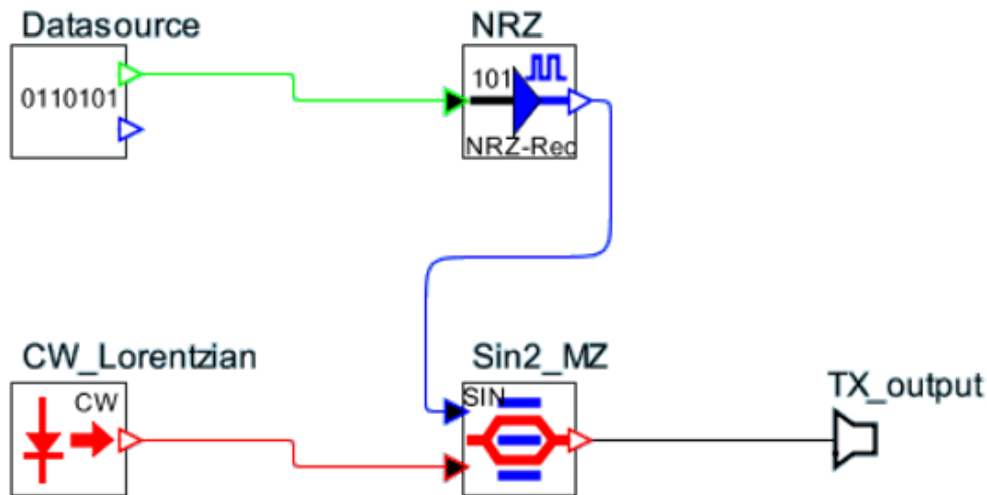

Figure 4.2: NRZ-OOK transmitter

An NRZ transmitter is based on a Continuous Wave (CW) laser and an external Mach-Zehnder modulator.

This modulation will be used in this work for representation of typical CWDM system and farther common DWDM systems. For example, infrastructure of DWDM system based on NRZ-OOK:

This example shows transmission of 16 NRZ-OOK channels over 25 and 100 kilometers, which is a very common information capacity and reach. On the receiver side three channels of 16 are studied (1 channel, 7 channel and 16 channel for the best results). Each channel capacity is 40 Gb/s, channel spacing is 0.1 THz that matches ITU-T Recommendations [3]. Due to the short distances of tests, I can assume that NRZ-OOK modulation must present high Q-factor (small BER) results. Generally, the transmission must be

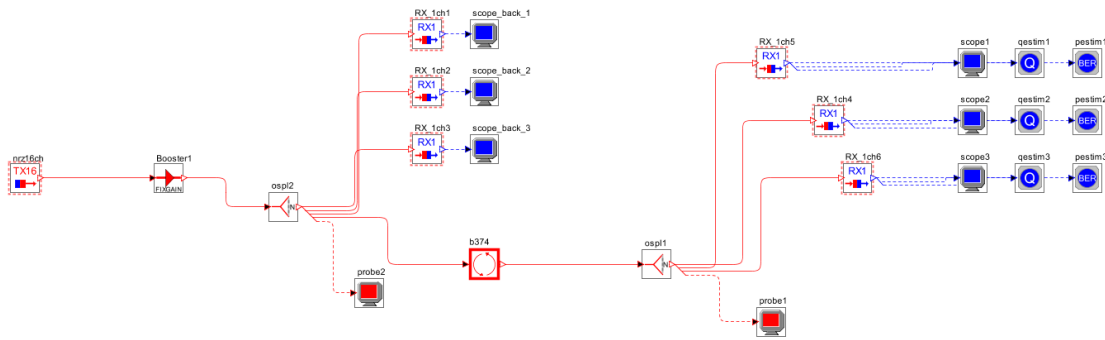

Figure 4.3: 16 channel NRZ-OOK DWDM topology

caused by FWM nonlinear effect.

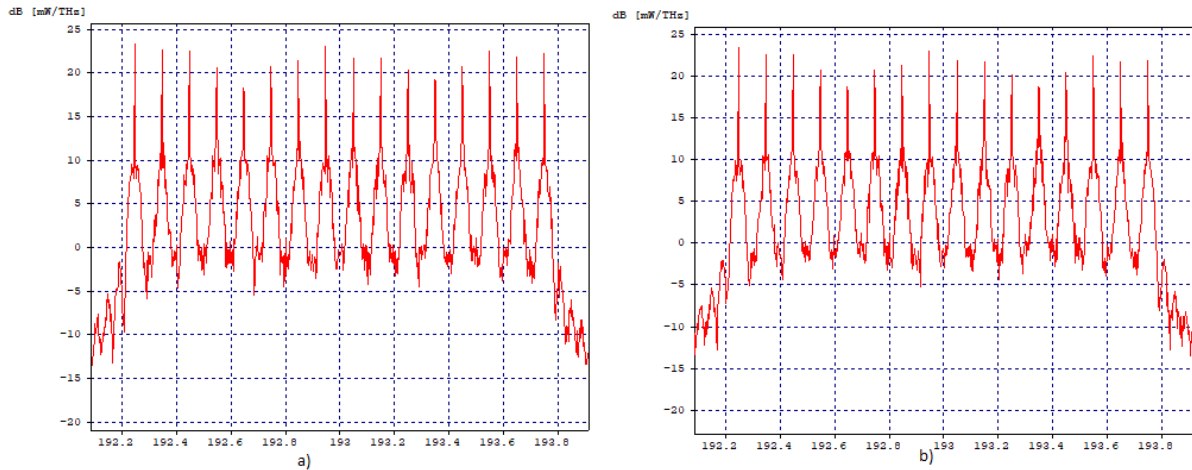

Figure 4.4: Optical Spectrum of NRZ-OOK DWDM system. a)25 km b)100 km

Usually, NRZ-OOK modulation is not popular in use with DWDM systems. Using NRZ-OOK with too close channel spacing and high bit rate defined for DWDM systems are caused by nonlinear processes like FWM, which is detected on both sides of optical spectrum. This processes causes output values, as it shown in fig. 4.5 – 4.7

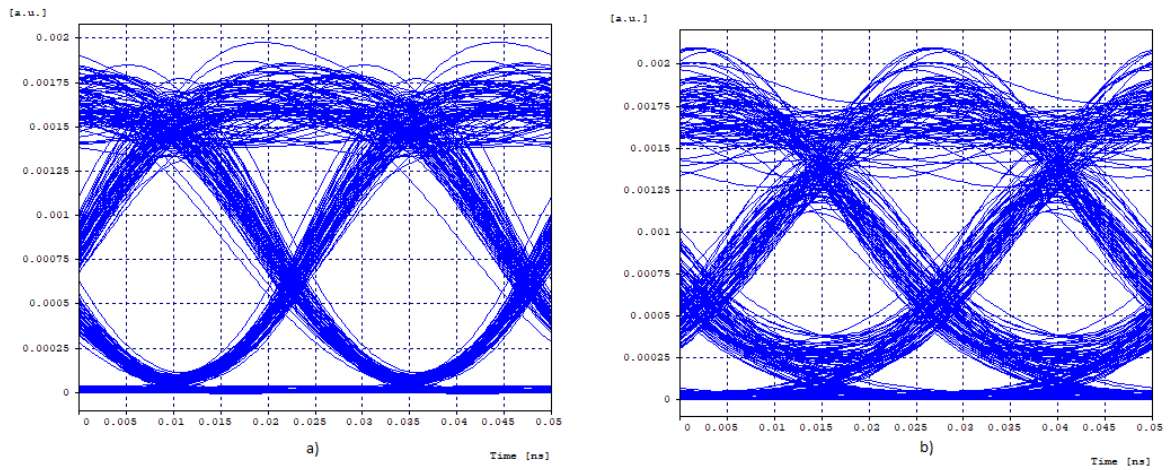

Figure 4.5: Eye diagrams NRZ-OOK channel 1. a)25 km b)100 km

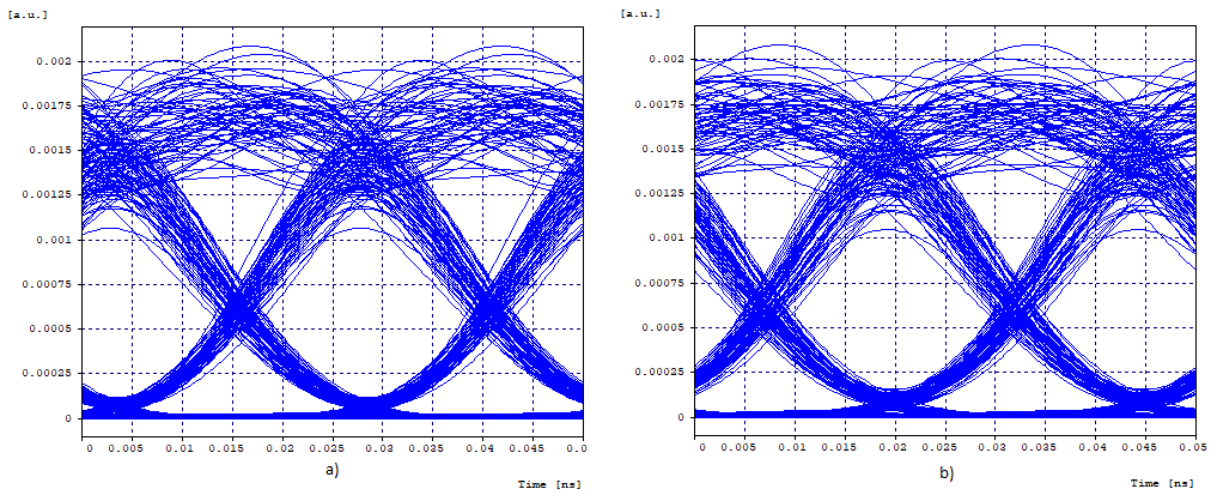

Figure 4.6: Eye diagrams NRZ-OOK channel 7. a)25 km b)100 km

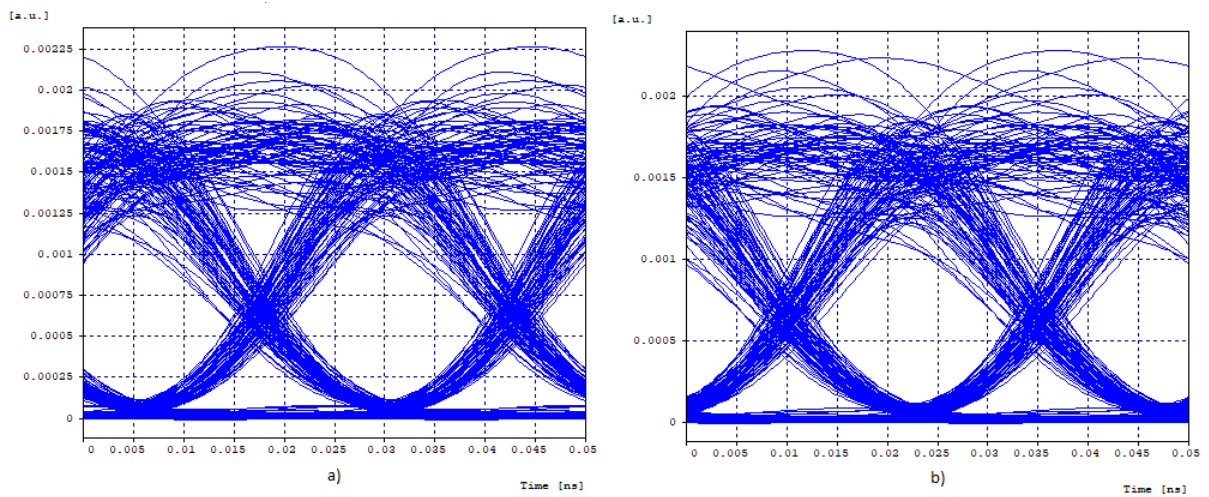

Figure 4.7: Eye diagrams NRZ-OOK channel 16. a)25 km b)100 km

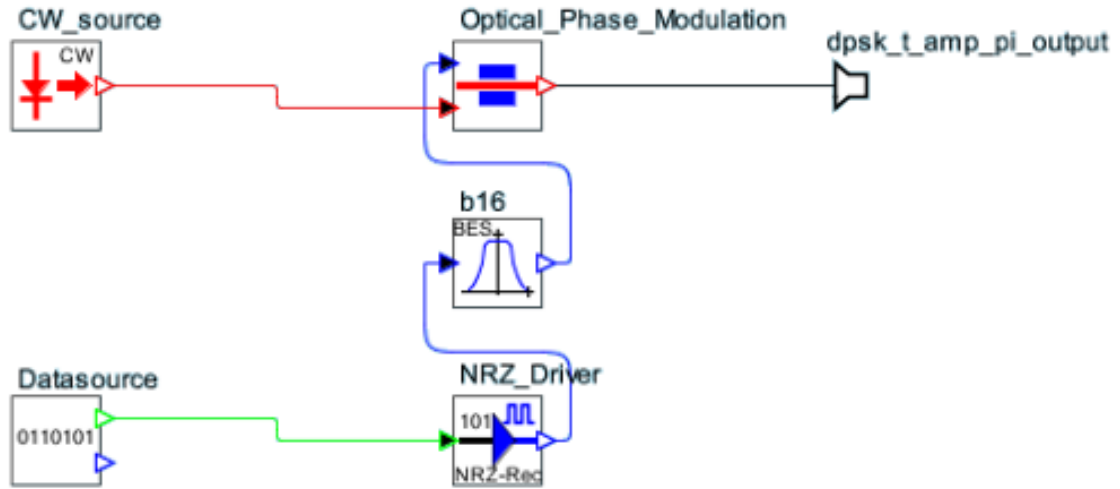

Figure 4.8: DPSK transmitter

Results are placed in following table:

Table 4.2: Comparison NRZ-OOK DWDM outputs over 25/100 km

Channel	Distance	BER	Q-factor
1	25	$8.75 \cdot 10^{-31}$	11.7 (21.36 dB)
1	100	$7.8 \cdot 10^{-8}$	5.24 (14.39 dB)
7	25	$1.46 \cdot 10^{-12}$	7.1 (17.03 dB)
7	100	$6.4 \cdot 10^{-11}$	6.74 (16.57 dB)
16	25	$9.43 \cdot 10^{-14}$	7.39 (17.38 dB)
16	100	$7.18 \cdot 10^{-12}$	6.88 (16.75 dB)

As it was previously noticed, DWDM systems can be affected by nonlinear processes like FWM, which appears between all 16 channels and dramatically influences output results. But the major processes causes presented example is cross-channel interference (they will appear ref about cross-channel interference) As it shown in Table 4.1, BER and Q-factor gradually goes down channel by channel and this decline stops precisely at the middle of transmitted signals bandwidth. After that point output values start to rise back. Attenuation depends on many factors: not ideal transmitter and receiver tuning, influence of optical elements, such as optical amplifiers, optical fiber and its components.

### 4.3 Differential Phase-shift Keying (DPSK)

Differential Phase-shift Keying is a relatively simple phase key modulation. Each symbol carries only one bit of information with either logical 1 at a determined phase or logical 0 at the opposite phase, resulting in very high symbol distance [5].

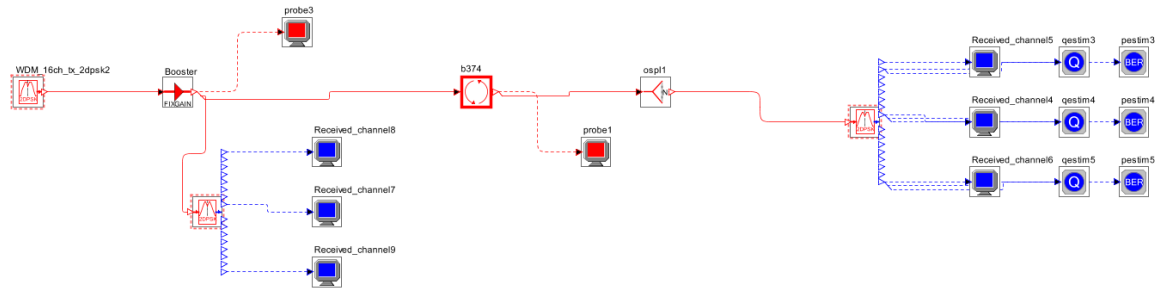

Figure 4.9: 16 channel DPSK DWDM topology

Optical phase modulator is used to change the phase by  $\pi$  of a signal from Lorentzian laser source based on electrically transmitted data. The DPSK modulation optical receiver must be supplemented with balanced detector, consisting of two PIN diodes and a delayed Mach-Zehnder Delay Interferometer.

The main advantages of DPSK modulation are better tolerance compared to NRZ-OOK, high resistance to non-linear effects, resulting in the ability to overcome large transmission distances compared to other modulations [19]. Supposed statements are approved by the following simulations results.

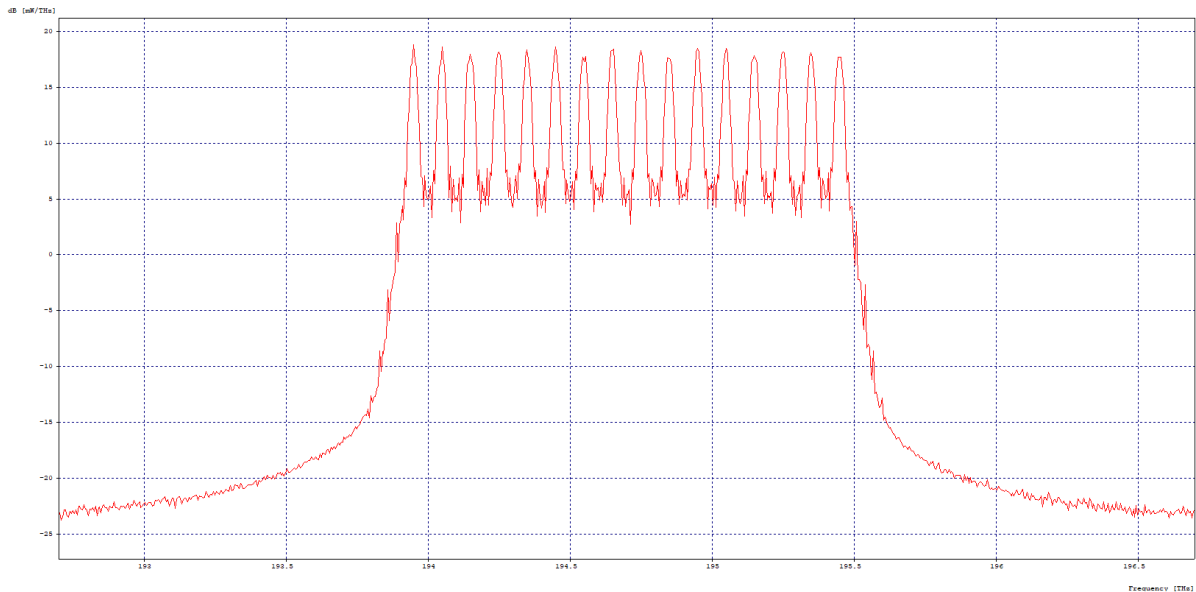

Figure 4.10: Optical spectrum of 16 channel DPSK DWDM system. 25 km distance



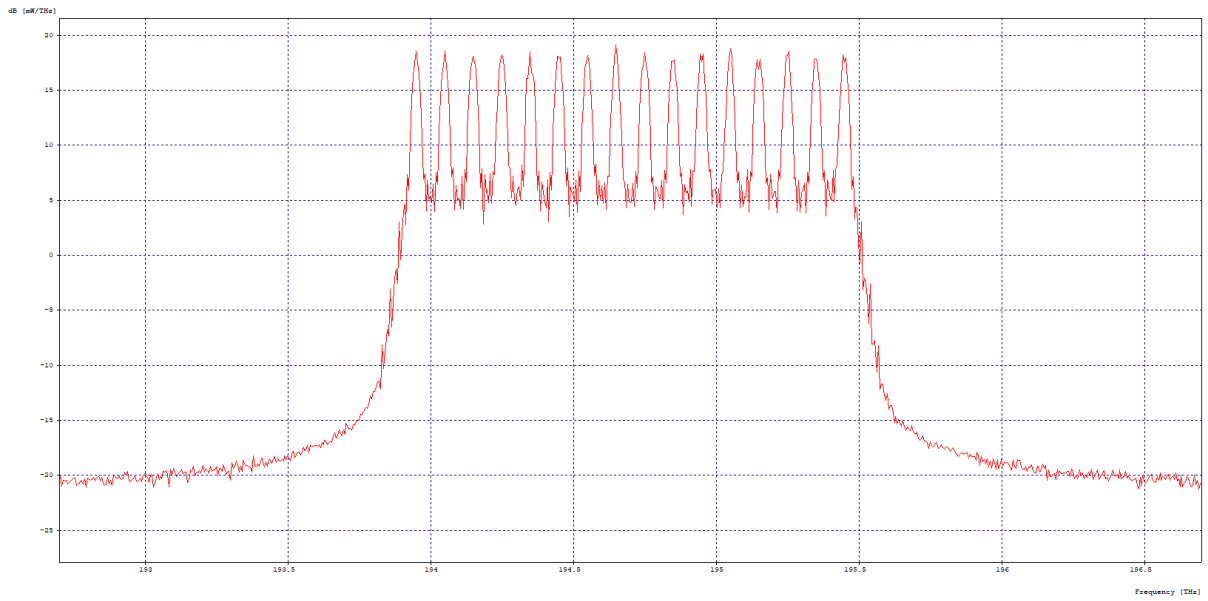

Figure 4.11: Optical spectrum of 16 channel DPSK DWDM system. 100 km distance

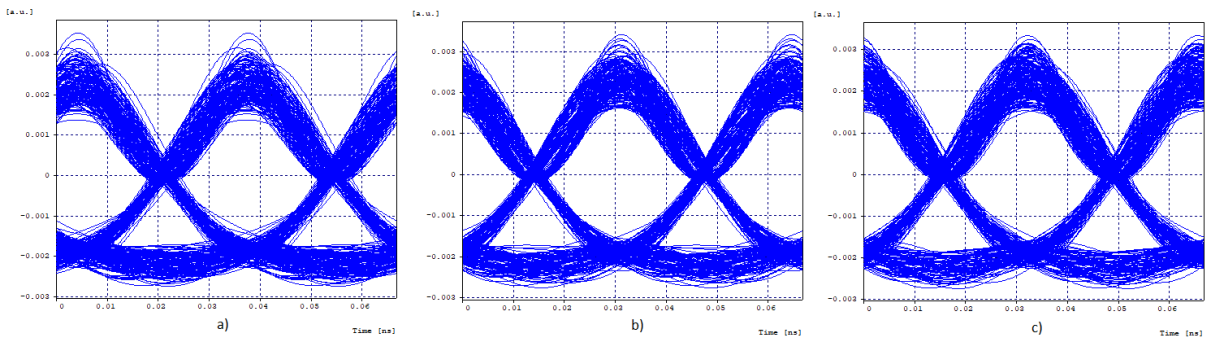

Figure 4.12: Eye Diagrams DPSK over 25 km. a) Channel 1 b) Channel 7 c) Channel 16

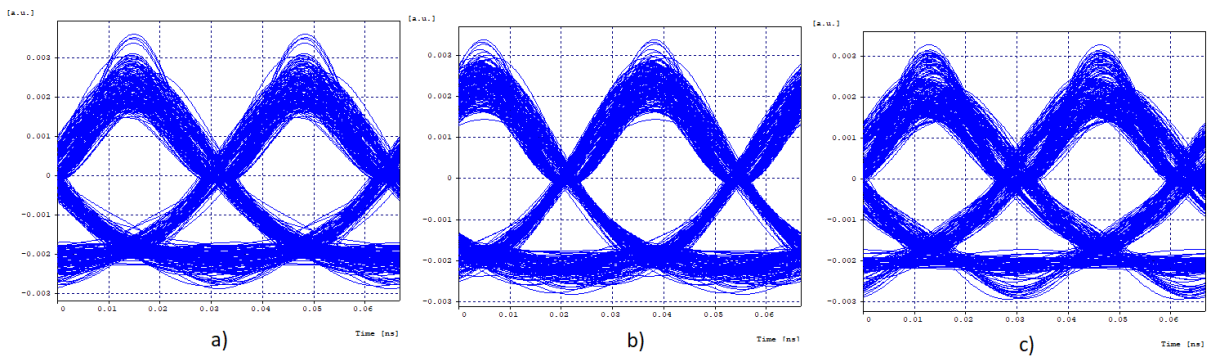

Figure 4.13: Eye Diagrams DPSK over 100 km. a) Channel 1 b) Channel 7 c) Channel 16

Results are shown in the following table 4.3

Table 4.3: Comparison DPSK DWDM outputs over 25/100 km

Channel	Distance	BER	Q-factor
1	25	$5.13 \cdot 10^{-16}$	8.04 (18.10 dB)
1	100	$1.63 \cdot 10^{-15}$	8.08 (18.15 dB)
7	25	$1.97 \cdot 10^{-14}$	7.60 (17.62 dB)
7	100	$3.68 \cdot 10^{-12}$	6.83 (16.69 dB)
16	25	$2.92 \cdot 10^{-14}$	7.5 (17.50 dB)
16	100	$5.84 \cdot 10^{-9}$	5.74 (15.17 dB)

The Results of DPSK based DWDM systems are better than NRZ-OOK system due to strict bandwidth filtering. Strong narrow-band filtering leads to warp phase relations between the neighboring bits. These results do not recommend implementation of DPSK, but transmission systems with a reduced spectral efficiency (less than 0.4 bit/s/Hz) would profit from DPSK implementation because of suppression of intra-channel limitations.

## 4.4 Quadrature amplitude modulation (QAM)

Quadrature amplitude modulation (QAM) is a modulation method frequently used in modern telecommunication systems. It carries two digital bit streams, by modulating the amplitudes of two carrier waves. The waves of the same frequency are in orthogonal phases with each other called quadrature. Quadrature Phase-Shift Keying (QPSK) usually regarded as a similar to QAM, because its resembling constellation diagram.

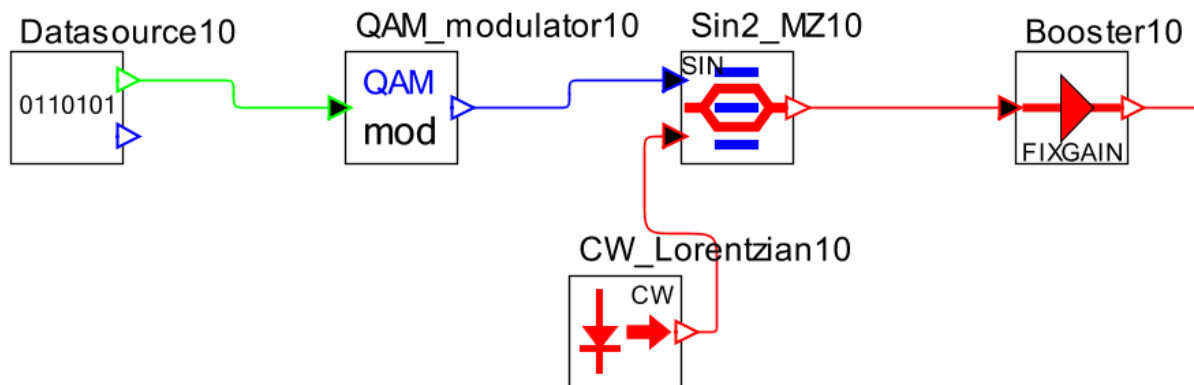

Figure 4.14: QAM transmitter

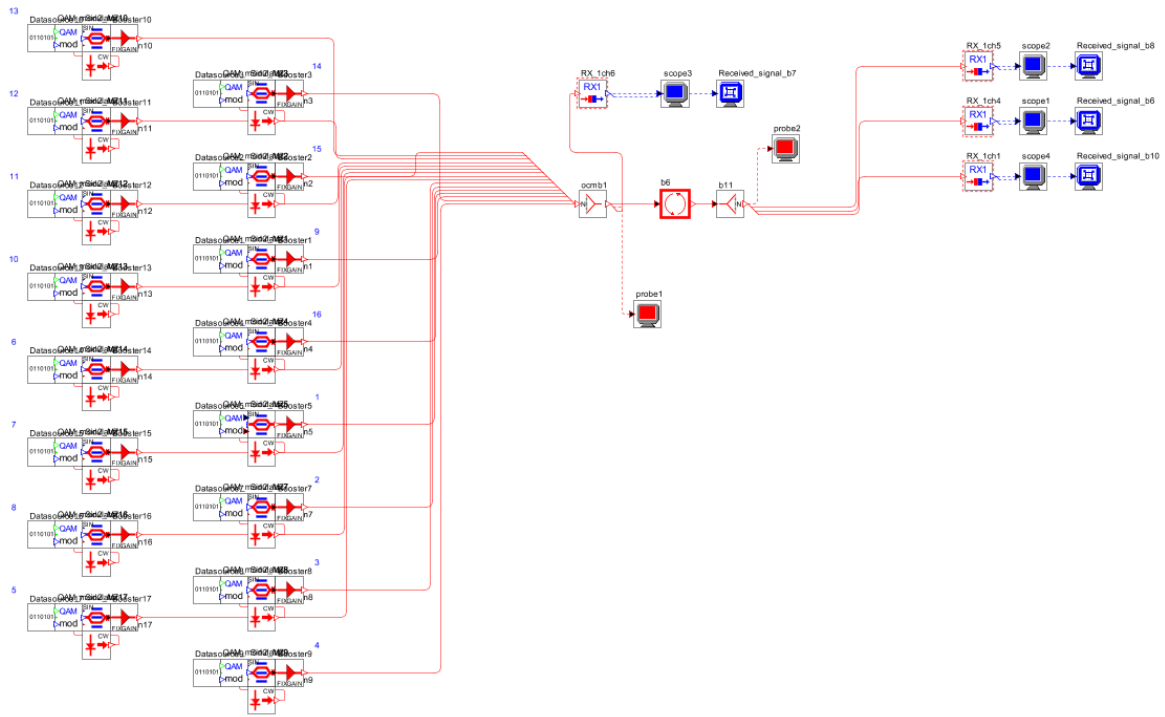

Figure 4.15: 16 QAM DWDM system topology

QAM tests in DWDM system show the high spectral efficiency achieved with incredibly precise tuning of the constellation size, limited by the noise level and linearity of the communications channel, transmitter and receiver sides parameters that depend on transmission reach, central frequencies, bit rate, pre-amplifiers' and amplifiers' gains. As it can be assumed, QAM tests should show the best output results both at a distance of 25 km and 100 km.

- Central frequency 193.415 THz
- 40 Gb/s per channel
- 16 channel with 100 GHz spacing

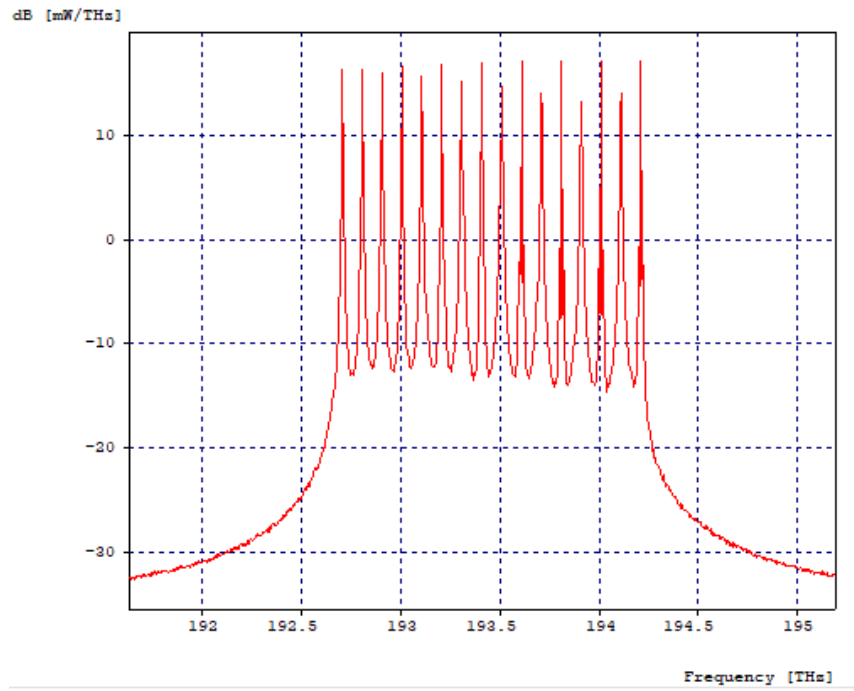

Figure 4.16: 16 QAM DWDM system topology

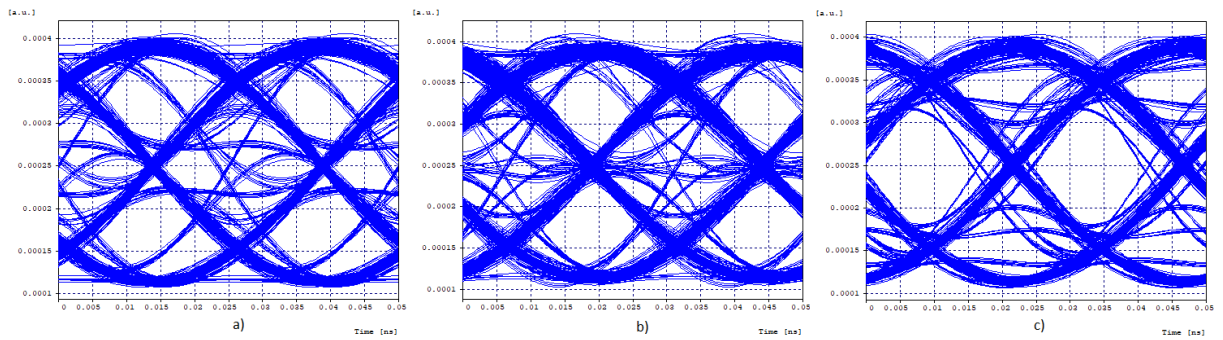

Figure 4.17: Eye Diagrams QAM over 25 km. a) Channel 16 b) Channel 7 c) Channel 1

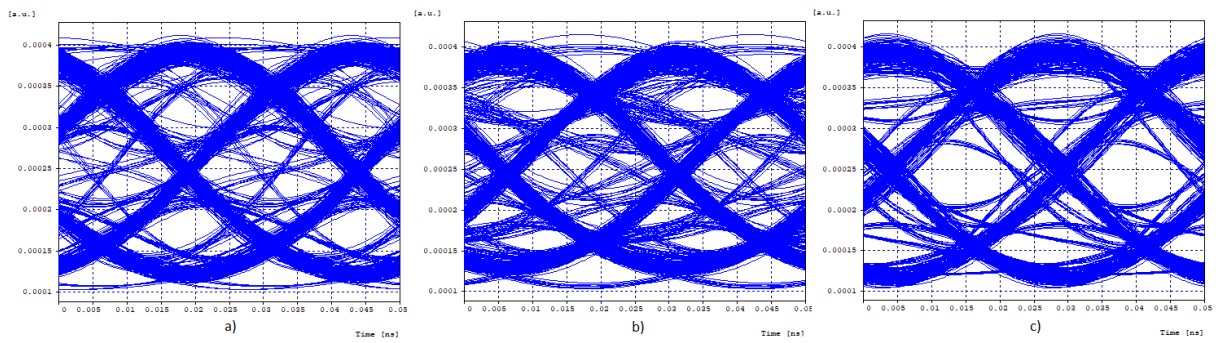

Figure 4.18: Eye Diagrams QAM over 100 km. a) Channel 7 b) Channel 16 c) Channel 1

Results are shown in the following Table 4.4

Table 4.4: Comparison QAM DWDM outputs over 25/100 km

Channel	Distance	BER	Q-factor
1	25	$1.40 \cdot 10^{-36}$	13.01 (22.29 dB)
1	100	$1.24 \cdot 10^{-14}$	7.70 (17.73 dB)
7	25	$8.67 \cdot 10^{-7}$	4.82 (13.67 dB)
7	100	$1.03 \cdot 10^{-6}$	4.80 (13.62 dB)
16	25	$1.17 \cdot 10^{-7}$	5.19 (14.30 dB)
16	100	$6.48 \cdot 10^{-7}$	4.85 (13.72 dB)

QAM results are extremely lower than the previous modulations results. It explained by a number of shortcomings of the tests. First of all, QAM eye diagrams displays one of four sub-carriers of each channel without upcoming demodulator. That's why multi-channel interference is clearly visible at shown outputs. The second notice is a influence of selected type of fiber. Standard Single Mode Fiber causes decline of output results. After some tests it can be confidently supposed that tested QAM modulation is very sensitive to fiber dispersion. That problem can be solved by setting wavelengths recommended by ITU-T. Third, it was noticed, that small increases of bit rate instantly causes BER by thousands points. It can be explained by the strong influence of nonlinearities of channels, first of all XPM and FWM, approved by eye diagrams results.

## 4.5 Consequences

Based on the test results, I can conclude, that DWDM systems interference are caused by FWM, which appears among all 16 channels and dramatically influences output results. NRZ-OOK modulation is strongly influenced by FWM and cross-channel interference due to high bit rate.

The Results of DPSK based DWDM systems output errors are caused by narrow-band filtering leads to warp phase relations between the neighboring bits.

QAM results are extremely lower than the previous modulations results. QAM modulation is very sensitive to fiber dispersion. Influence of dispersion can be suppressed by using Non-Zero Disperse-Shifted Fibers (NZDSF), shifted closer to 1550 nm band wavelengths. Small increases of bit rate instantly influence BER by thousands points. high impact was captured by XPM and FWM, approved by eye diagrams results.

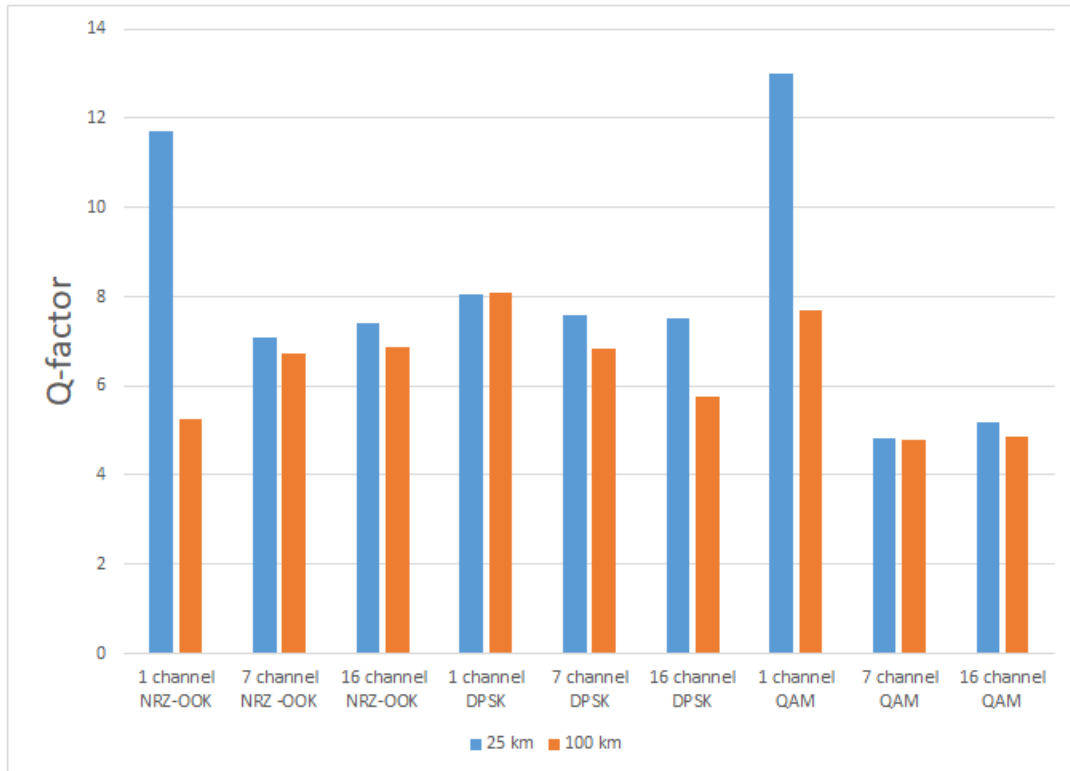

Figure 4.19: Comparison of Q-factor over 25 and 100 km

According to the section 3.3,  $BER = 10^{-9}$  corresponds to Q-factor of 6. Also, this value of BER is recommended by ITU-T as a minimal for stable transmission. At a distance of 25 kilometers received outcomes of QAM channels do not match to minimal BER. DPSK system outputs are among the most resistant to changes, which can be considered the best indicator in this chapter.

# Chapter 5

## Results

This chapter is focused on testing and comparing the coexistence of the selected optical systems on a common physical layer of optical transmission networks. This chapter deals with comparing the potential pairs of optical system. Firstly, the coexistence of CWDM and DWDM systems will be presented and compared by using some output criteria for different modulations. Advantages and limitations of selected type of coexistence will be compared and analyzed. Secondly, coexistence of two different DWDM systems on a mutual physical layer will be studied. The chapter concludes with the best options for using a pair of systems for different requirements of optical networks.

### 5.1 DWDM over CWDM

In this section, the systems implemented in the existing CWDM system are studied. This system is realized using 8 NRZ-OOK modulation channels. The channel, which is located on the C band (1550 nm), is replaced by 16 DWDM channels. This method of implementation is widely used in the improvement of optical systems [7]. This increases the capacity of the entire system. Also in this chapter are three modulations that have already been used in the work. Changes in the output results are described and analyzed. Before conducting the tests, I conducted investigation of the behavior of the modulations. in the case of using only NRZ-OOK for both systems, the output should be extremely satisfactory from the point of view of minimum errors. It depends on the short distance chosen for the test (50 kilometers), it also depends on the simplicity of the modulation design. FWM should have a big impact on the results. in the case of DPSK modulation, system stability is expected to be at a good level. The modulation difference between DWDM and CWDM systems can lead to unexpected changes in the output. DWDM channel transmission using QAM modulation is expected to be low. However, CWDM channels should not affect the increase in the number of errors.

### 5.1.1 DPSK over NRZ-OOK

Sixteen DWDM channels each of 40 Gb/s and seven CWDM channels each of 10Gb/s, are transmitted over 2 spans (25 km per span) of Standard Single Mode Fiber (SSMF). The 16 DWDM channels are spaced at 100 GHz. The 7 CWDM channels are spaced at 2000 GHz. The signals are amplified by an EDFA booster and transmitted over on optical amplified link. Fiber dispersion is compensated after each in-line EDFA using an ideal fiber grating. At the receiver side all of the 7 channels CWDM and 3 of 16 channels of DWDM are studied.

CWDM

- 8x10 Gb/s channels with 2000 GHz spacing - 1482.91 nm - 1606.045 nm.

DWDM

- Replacement of the 5th channel in CWDM (1550 nm).
- DWDM with 16x40 Gb/s channels with 100 GHz spacing.

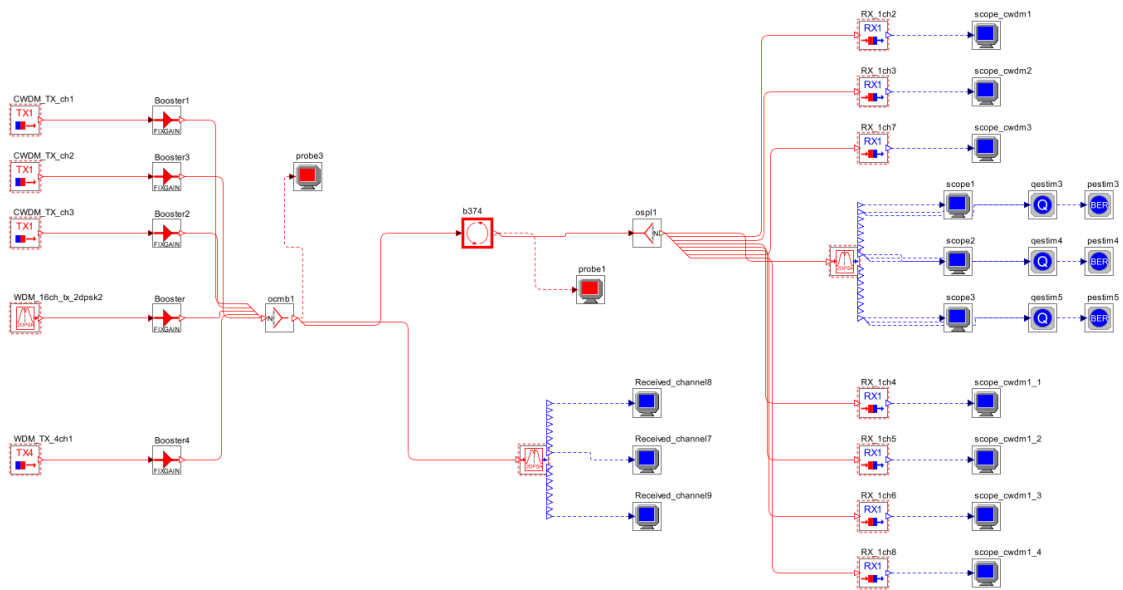

Figure 5.1: 16 channels DPSK over 7 channels NRZ-OOK topology



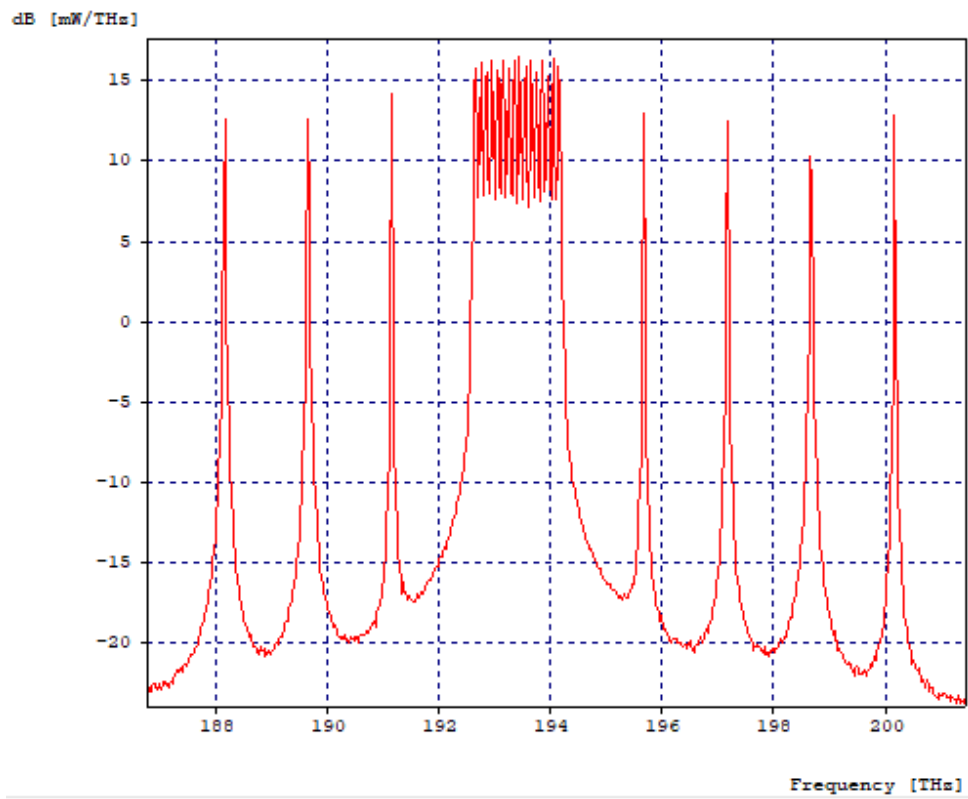

Figure 5.2: 16 DPSK DWDM over 7 NRZ-OOK CWDM optical spectrum

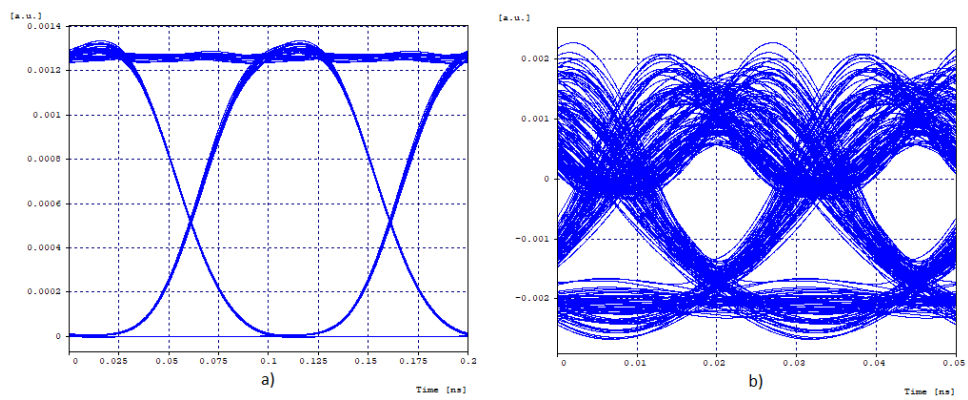

Figure 5.3: Eye diagrams a) NRZ-OOK channel b) DPSK channel

Table 5.1: Performance of evaluation criteria of DPSK DWDM over NRZ-OOK CWDM system

Channel	BER	Q-factor
Channel 1 DPSK	$2.08 \cdot 10^{-9}$	6.03 (15.61 dB)
Channel 7 DPSK	$1.59 \cdot 10^{-9}$	5.92 (15.46 dB)
Channel 16 DPSK	$3.31 \cdot 10^{-9}$	5.91 (15.44 dB)
Channel 1 NRZ-OOK	$1 \cdot 10^{-40}$	44.74 (33.01 dB)
Channel 4 NRZ-OOK	$1 \cdot 10^{-40}$	99.09 (39.91 dB)
Channel 7 NRZ-OOK	$1 \cdot 10^{-40}$	27.31 (28.72 dB)

Due to ideal environment of software, the CWDM channels outputs create incredibly qualitative transmission infrastructure, which exhibits no error over 50 kilometers distance, which theoretically can be reduced by decreasing the optical filter bandwidth. As it could be explained, CWDM channels has less influences on each other than DWDM due to bigger channel spacing. Practicable processes regardless of values are represented by changes of Q-factor in Table 5.1 In this case previous results of DPSK channels assume added new multi-channel nonlinearities, such as Self-phase modulation, which are appeared due to adjacent DWDM and CWDM channels. In fact, existing CWDM channels causes Bit Error Rate of DPSK channels, but not vice versa.

### 5.1.2 QAM over NRZ-OOK

16 QAM channels each of 40 Gb/s and seven CWDM channels each of 10Gb/s, are transmitted over 2 spans (25 km per span) of SSMF. The 16 DWDM channels are spaced at 100 GHz. The 7 CWDM channels are spaced at 2000 GHz. The signals are amplified by an EDFA booster and transmitted over on optical amplified link. Fiber dispersion is compensated after each in-line EDFA using an ideal fiber grating. At the receiver side all NRZ-OOK channels CWDM and 3 of 16 QAM channels are studied.

CWDM

- 8x10 Gb/s channels with 2000 GHz spacing - 1497.5 nm -1595.065 nm

CWDM/DWDM

- Replacement of the 5th channel in CWDM (1550 nm).
- DWDM with 40x16 Gbps channels with 100 GHz spacing.

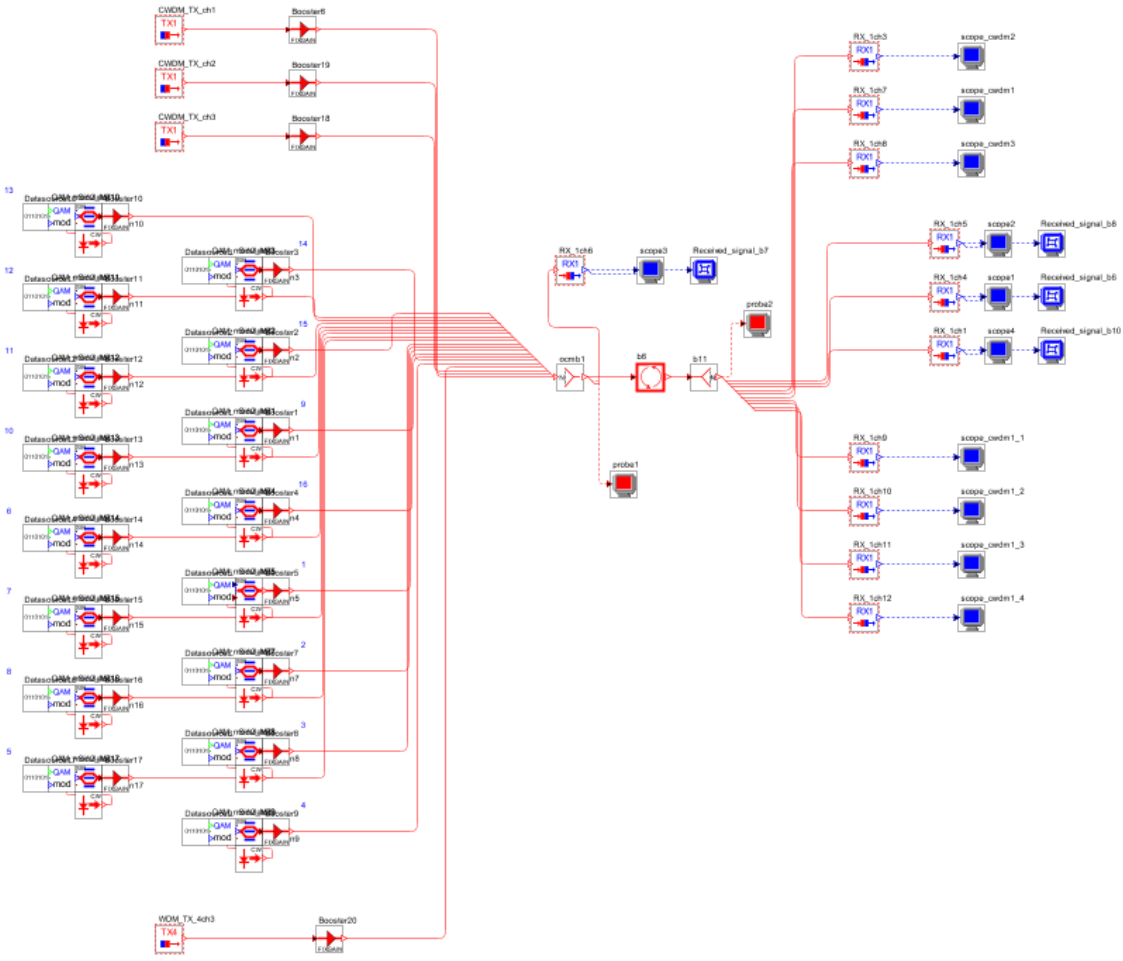

Figure 5.4: 16 channels QAM over 7 channels NRZ-OOK topology

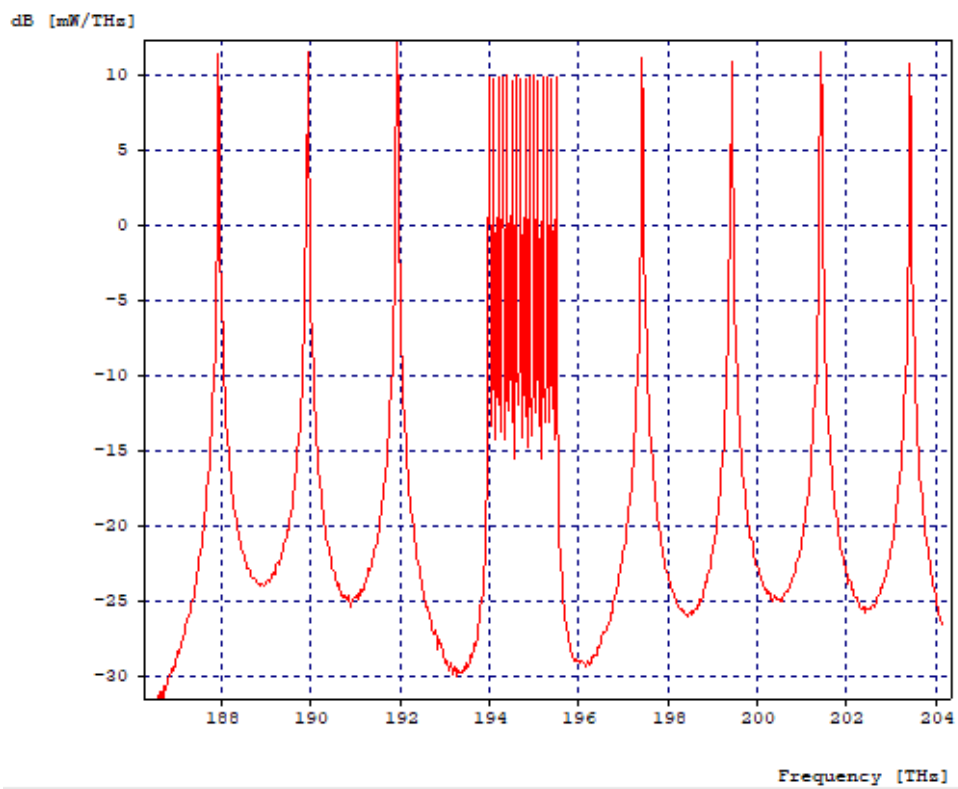

Figure 5.5: 16 QAM DWDM over 7 NRZ-OOK CWDM optical spectrum

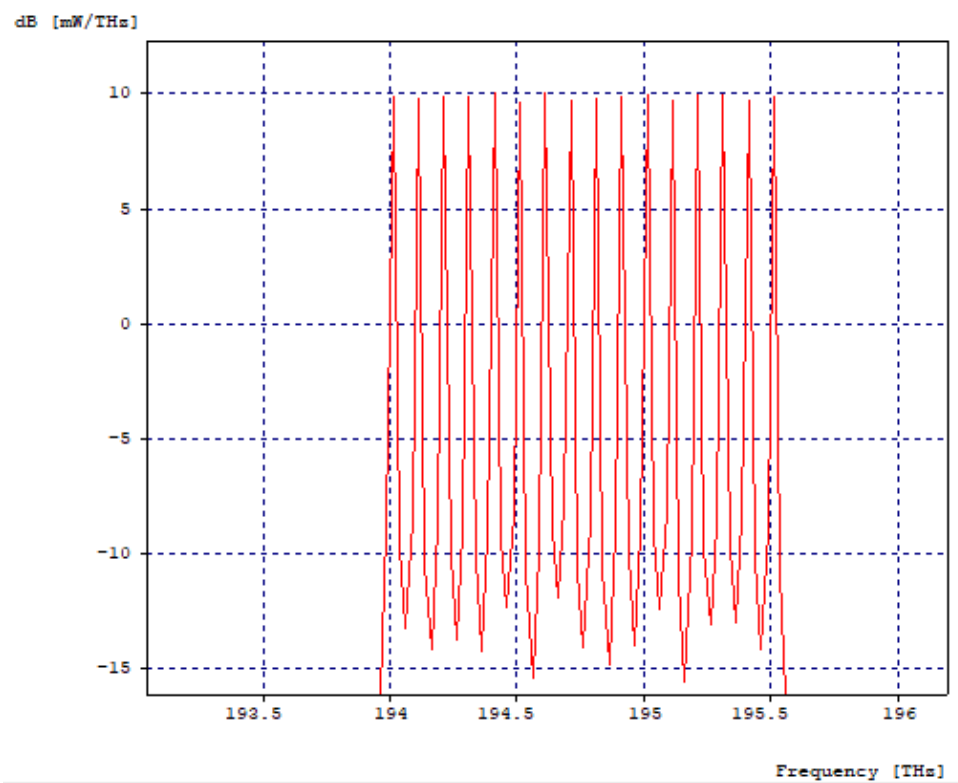

Figure 5.6: 16 QAM DWDM optical spectrum

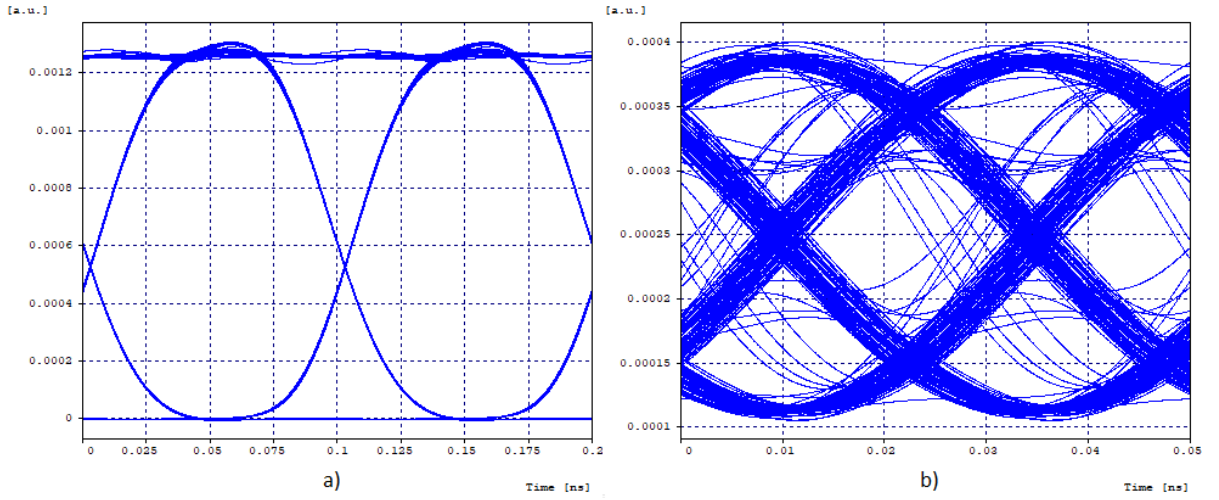

Figure 5.7: Eye diagrams a) NRZ-OOK channel b) QAM channel

Table 5.2: Performance of evaluation criteria of QAM DWDM over NRZ-OOK CWDM system

Channel	BER	Q-factor
Channel 1 QAM	$6.40 \cdot 10^{-11}$	6.59 (16.39 dB)
Channel 7 QAM	$2.11 \cdot 10^{-13}$	7.25 (17.20 dB)
Channel 16 QAM	$2.37 \cdot 10^{-5}$	4.24 (12.55 dB)
Channel 1 NRZ-OOK	$1 \cdot 10^{-40}$	72.03 (37.15 dB)
Channel 4 NRZ-OOK	$1 \cdot 10^{-40}$	99.1 (39.92 dB)
Channel 7 NRZ-OOK	$1 \cdot 10^{-40}$	23.79 (27.53 dB)

As it was previously noticed, CWDM channels have no errors due to ideal software environment. Real results correlation of CWDM channels could be represented by changes of Q-factor in Table 5.2. The worst output results of DWDM channels (channel 1 and channel 16) could be explained as a narrow-band filtering impact in conjunction with multi-channel nonlinearities. High BER is a result of setting attempt of the highest bit rate. For example, 10 Gbit/s per channel QAM settings shows  $10^{-20}$  BER on the average.

### 5.1.3 NRZ-OOK over NRZ-OOK

16 NRZ-OOK channels each of 40 Gb/s and seven CWDM channels each of 10Gb/s, are transmitted over 50 km (2 span, 25 km per span) of SSMF. The 16 DWDM channels are spaced at 100 GHz. The 7 CWDM channels are spaced at 2000 GHz. The signals are amplified by an EDFA booster and transmitted over on optical amplified link. Fiber dispersion is compensated after each in-line EDFA using an ideal fiber grating. At the receiver side all NRZ-OOK channels CWDM and 3 of 16 NRZ-OOK DWDM channels are studied.

CWDM

- 8x10 Gbps channels with 2000 GHz spacing - 1485.96 nm -1609.624 nm

CWDM/DWDM

- Replacement of the 5th channel in CWDM (1553.33 nm).
- DWDM with 40x16 Gb/s channels with 100 GHz spacing.

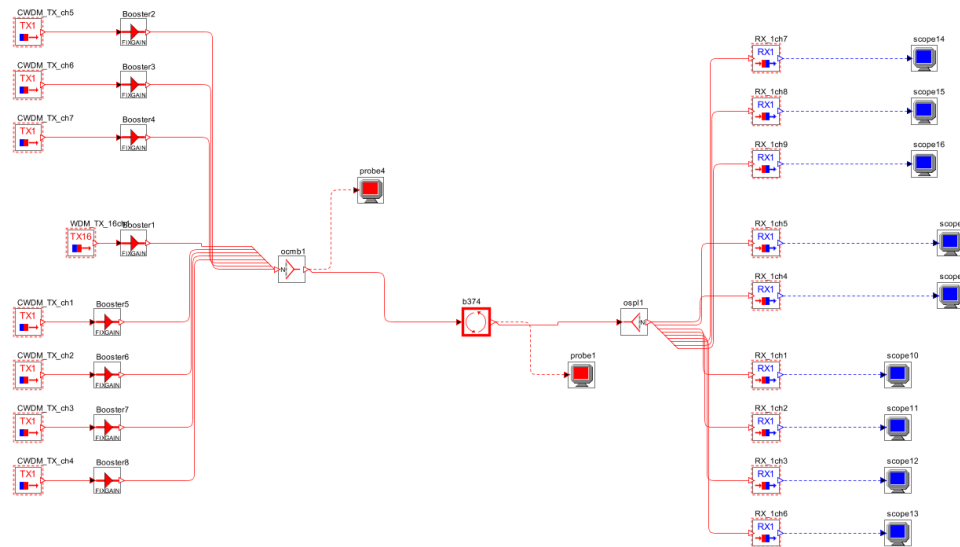

Figure 5.8: 16 channels NRZ-OOK over 7 channels NRZ-OOK topology

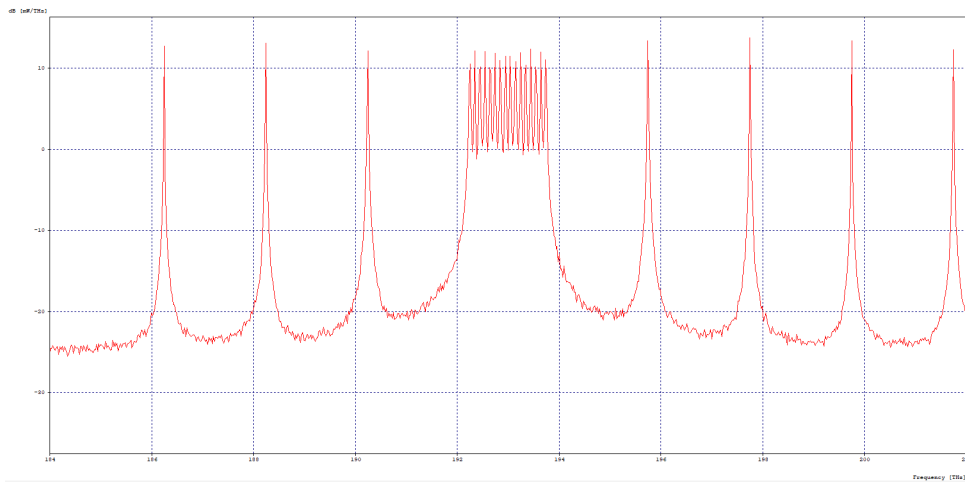

Figure 5.9: 16 NRZ-OOK DWDM over 7 NRZ-OOK CWDM optical spectrum

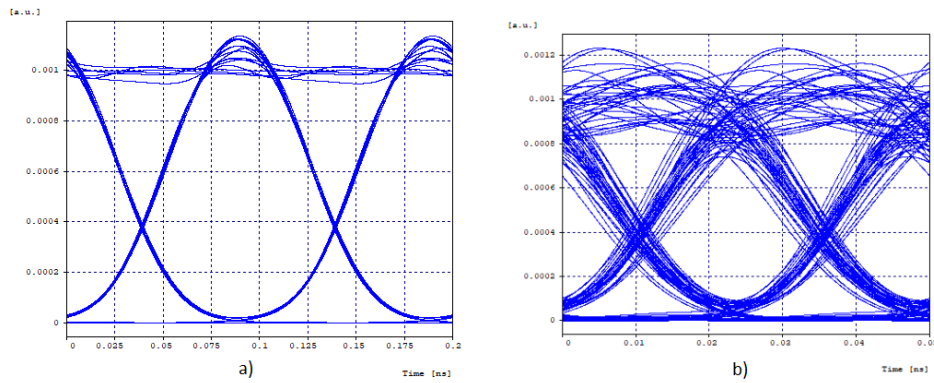

Figure 5.10: Eye diagrams a) NRZ-OOK CWDM channel b) NRZ-OOK DWDM channel

Table 5.3: Performance of evaluation criteria of NRZ-OOK DWDM over NRZ-OOK CWDM system

Channel	BER	Q-factor
Channel 1 DWDM	$5.40 \cdot 10^{-13}$	7.09 (17.02 dB)
Channel 7 DWDM	$2.93 \cdot 10^{-11}$	6.52 (16.28 dB)
Channel 16 DWDM	$4.11 \cdot 10^{-28}$	11.11 (20.91 dB)
Channel 1 CWDM	$1 \cdot 10^{-40}$	32.09 (30.12 dB)
Channel 4 CWDM	$1 \cdot 10^{-40}$	85.14 (38.60 dB)
Channel 7 CWDM	$1 \cdot 10^{-40}$	22.54 (27.06 dB)

The main factor influencing the DWDM is the Four Wave Mixing, the value of which has almost no effect on channel 16. This nonlinearities could be suppressed by perfect tuning of laser sources and using non-zero dispersion shifted fibers. Overall, results of NRZ-OOK DWDM system over NRZ-OOK CWDM system are among the best in a distance of 50 kilometers.

#### 5.1.4 Consequences

The tests showed that the implementation of the channels of the DWDM system in the CWDM system is one of the qualitative improvements in the optical network. Speaking of CWDM channels, their results do not quite correspond to the real indicator of these systems. As already noted, the CWDM channels have no errors due to ideal software environment.

Comparison of DWDM systems is perfectly expressed in the figure. Indicators of QAM modulation, as expected, were one of the problems that it turned out to be solved by reducing the bit rate of the channels. channels with DPSK modulation as well as in previous tests showed the same level of quality. This suggests that the channels in DPSK modulation are weakly affected by the influence of neighboring CWDM channels.

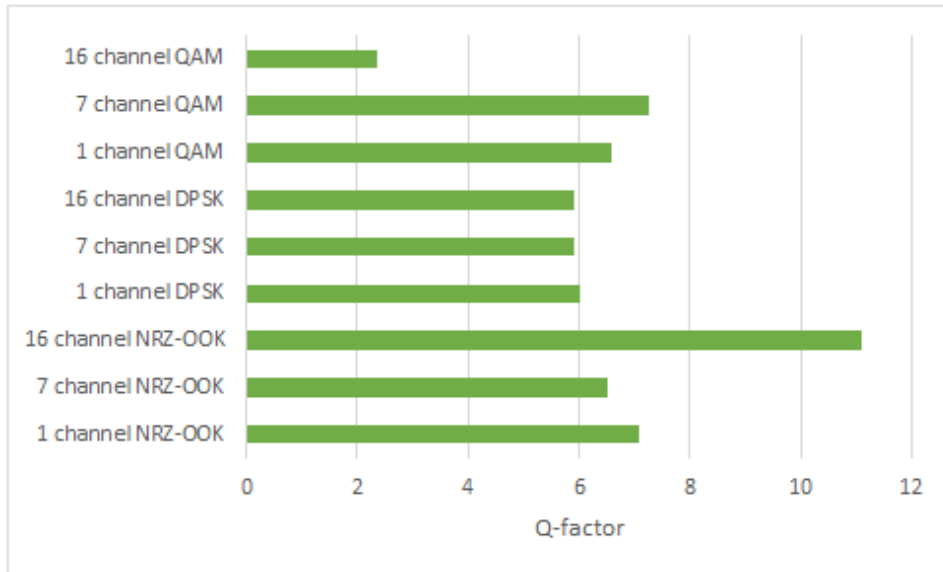

Figure 5.11: Comparison of Q-factor of DWDM systems

NRZ-OOK DWDM channel modulation in the tests showed the highest results.

Mainly, in order to reduce the number of data transmission errors of systems at a fairly short distance, as was the case in these tests, we must use fiber with a shifted non-zero dispersion. This may affect the quality of channels that are closer to the E band, but will significantly suppress the effect of dispersions on DWDM channels.[21]

## 5.2 DWDM/DWDM implemented

This section is focused on testing and comparing of coexistence of implemented DWDM systems on a common physical layer of optical transmission network. This section deals with comparing the possibilities and limitations of pairs of optical system. In this section, tests of DWDM systems implemented into each other in the Conventional and Short bands were carried out. This method exists as one of the possible implementations of two WDM systems.[22] Based on the theory, different modulations that are very close to each other at a distance of 100 GHz will greatly influence the results. Multichannel nonlinearities can lead to the complete destruction of signals on the receiving side. It also takes into account the fact that both modulations have a bit rate of 40 Gb / s.[24]

Due to the certain peculiarities of the systems, it is possible to distinguish the fact that to use DPSK modulation, a rather wide frequency band is required, which can lead to the effect of this modulation on adjacent channels.

It is assumed that the channels with NRZ-OOK and QAM modulation due to the basic method of transmitting information (Amplitude Shift Keying) will be affected both by the strong influence of FWM and other non-linear phenomena, such as GVD and



Multichannel nonlinearities

### 5.2.1 DPSK/NRZ-OOK

Sixteen NRZ-OOK channels each of 40 Gb/s and 16 DPSK channels each of 40 Gb/s, are transmitted over 2 spans (25 km per span) of Standard Single Mode Fiber. All channels are separated at 200 GHz on wavelength bands recommended by ITU-T. The signals are amplified by an EDFA booster and transmitted over optical amplified link. Fiber dispersion is compensated after each in-line EDFA using parts of ideal fiber grating. At the receiver side three channels of each modulation are studied.

NRZ-OOK

- 16x40 Gb/s channels with 200 GHz spacing - 1533.858 nm -1557.768 nm

DPSK

- 16x40 Gb/s channels with 200 GHz spacing - 1534.643 nm -1558.578 nm

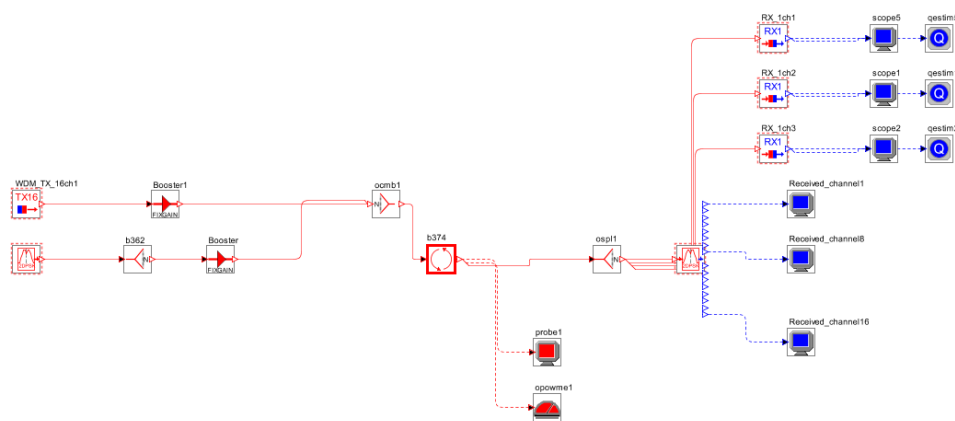

Figure 5.12: 16 channels NRZ-OOK and 16 channels DPSK hybrid topology of DWDM system

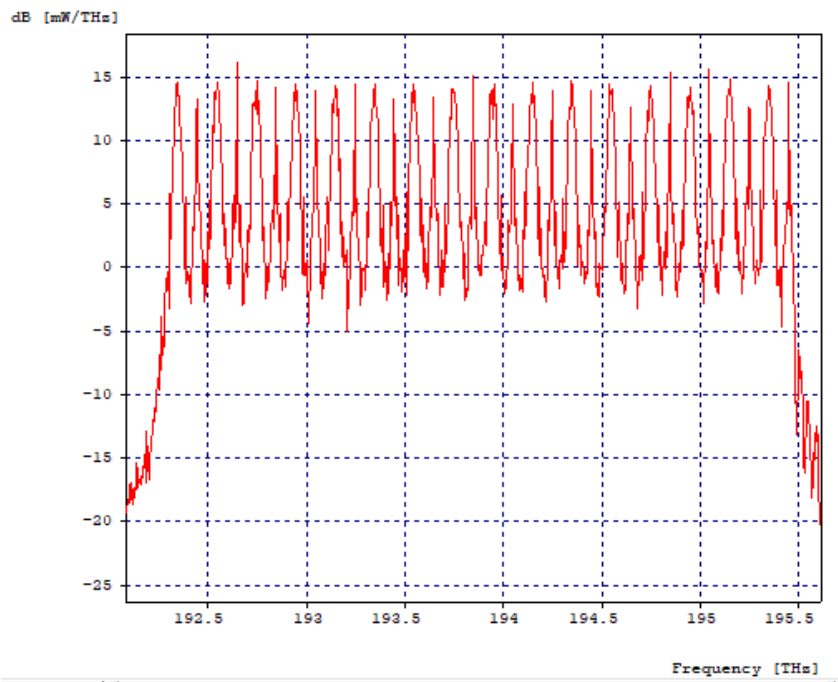

Figure 5.13: 16 NRZ-OOK and 16 DPSK hybrid systems optical spectrum

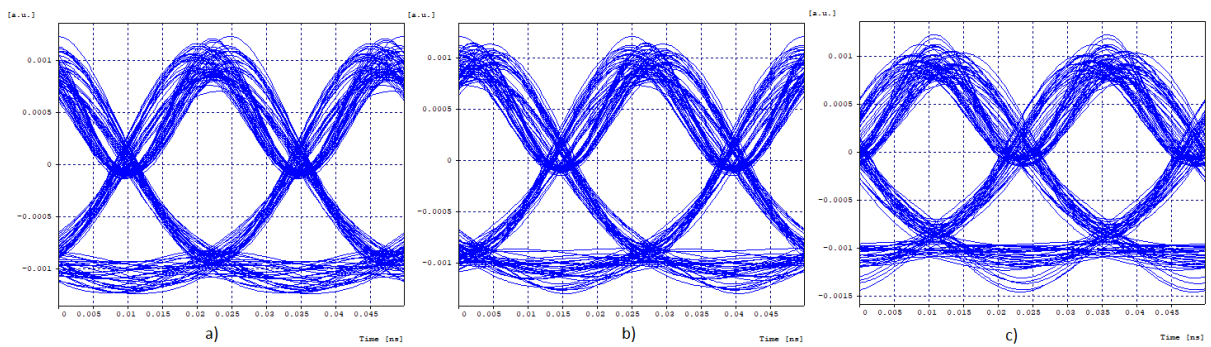

Figure 5.14: Eye diagrams a)channel 1 DPSK b)channel 7 DPSK c)channel 16 DPSK

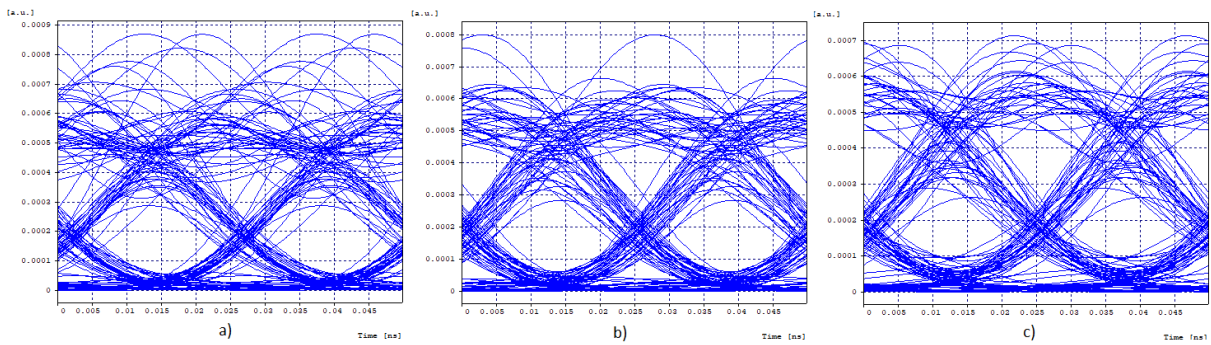

Figure 5.15: Eye diagrams a)channel 1 NRZ-OOK b)channel 7 NRZ-OOK c)channel 16 NRZ-OOK

Table 5.4: Performance of evaluation criteria of NRZ-OOK and DPSK DWDM systems

Channel	BER	Q-factor
Channel 1 NRZ-OOK	$7.86 \cdot 10^{-5}$	3.72 (11.42 dB)
Channel 7 NRZ-OOK	$7.15 \cdot 10^{-7}$	4.77 (13.58 dB)
Channel 16 NRZ-OOK	$2.57 \cdot 10^{-5}$	4.02 (12.08 dB)
Channel 1 DPSK	$7.35 \cdot 10^{-26}$	10.68 (20.57 dB)
Channel 7 DPSK	$1.66 \cdot 10^{-23}$	10.03 (20.02 dB)
Channel 16 DPSK	$3.64 \cdot 10^{-16}$	8.19 (18.26 dB)

As it was assumed, DPSK channels have the same nonlinearities, as it was detected and analyzed in chapter 5.4. Q-factor and BER of DPSK channels have better results due to wider bandwidth filtering. On the other hand, NRZ-OOK channels were disturbed by adjunct nonlinearities caused by neighboring DPSK channels. Another, but not less important indicator that violates the signal transmission in NRZ-OOK channels is narrow-band filtering. I called these disturbs of channel transmission "bottle neck principle". In fig. 5.13 every even channel is subject to this "principle". This problem could be resolved by increasing channel bandwidth, but it will affect neighbouring channels and will decrease its output results.

### 5.2.2 DPSK/QAM

Sixteen QAM channels each of 40 Gb/s and 16 DPSK channels each of 40 Gb/s, are transmitted over 2 spans (25 km per span) of SSMF fiber. All channels are separated at 200 GHz on wavelength bands recommended by ITU-T for DWDM systems. The signals are amplified by an EDFA booster and transmitted over optical amplified link. Fiber dispersion is compensated after each in-line EDFA using parts of ideal fiber grating. At the receiver side three channels of each modulation are studied.

#### QAM

- 16x40 Gb/s channels with 200 GHz spacing - 1538.072 nm -1561.866 nm

#### DPSK

- 16x40 Gb/s channels with 200 GHz spacing - 1538.861 nm -1562.929 nm

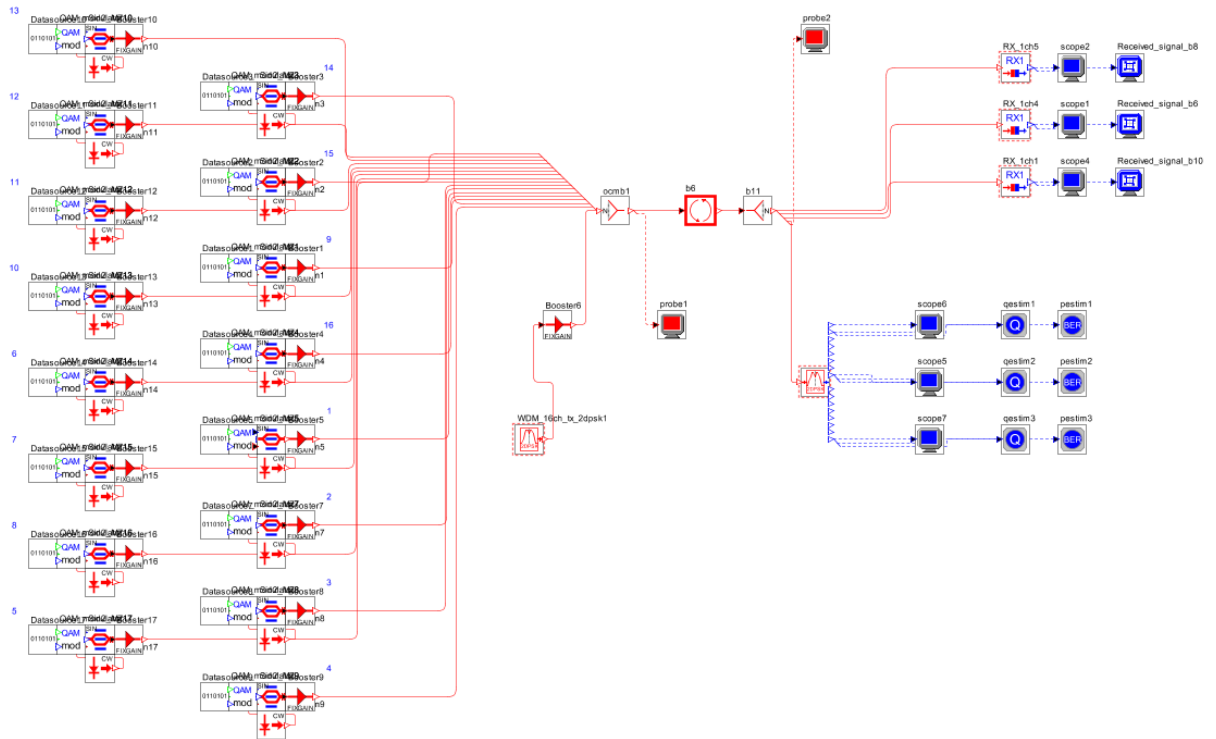

Figure 5.16: 16 channels QAM and 16 channels DPSK hybrid topology of DWDM system

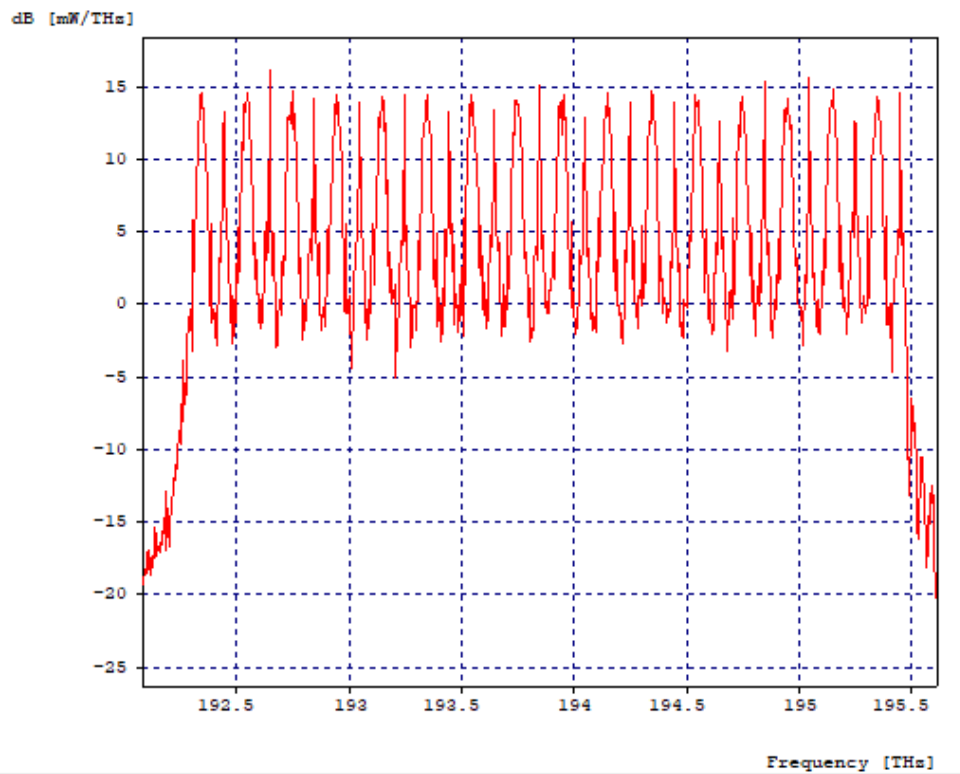

Figure 5.17: 16 QAM and 16 DPSK hybrid systems optical spectrum

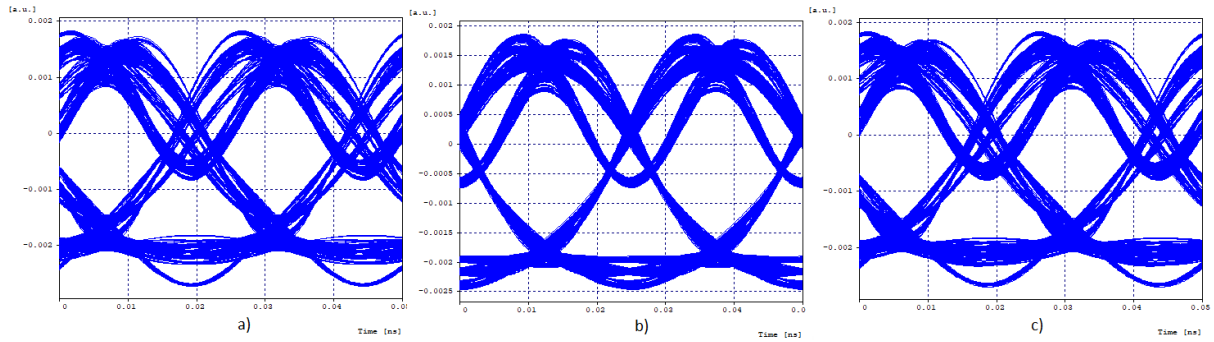

Figure 5.18: Eye diagrams a)channel 1 DPSK b)channel 7 DPSK c)channel 16 DPSK

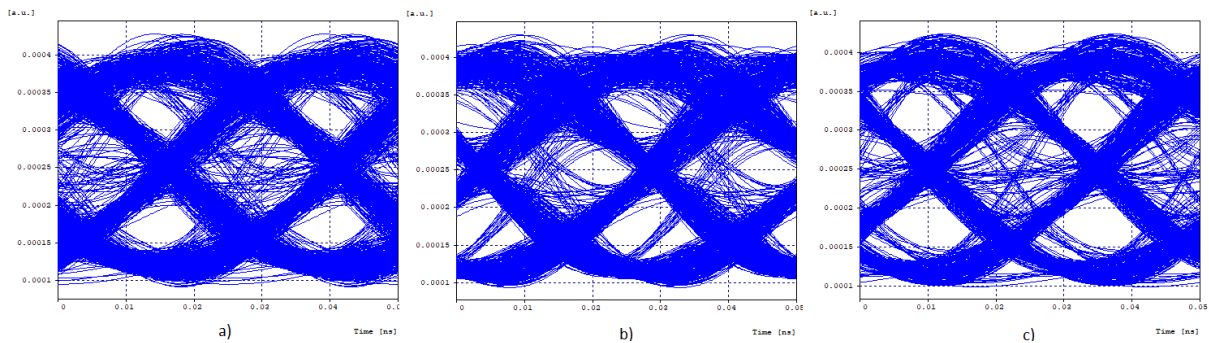

Figure 5.19: Eye diagrams a)channel 1 QAM b)channel 7 QAM c)channel 16 QAM

Table 5.5: Performance of evaluation criteria of QAM and DPSK DWDM systems

Channel	BER	Q-factor
Channel 1 QAM	$1.54 \cdot 10^{-5}$	4.17 (12.42 dB)
Channel 7 QAM	$3.43 \cdot 10^{-5}$	4.03 (12.10 dB)
Channel 16 QAM	$5.45 \cdot 10^{-6}$	4.39 (12.86 dB)
Channel 1 DPSK	$4.66 \cdot 10^{-19}$	9.01 (19.09 dB)
Channel 7 DPSK	$1.32 \cdot 10^{-29}$	11.62 (21.31 dB)
Channel 16 DPSK	$5.41 \cdot 10^{-19}$	9.10 (19.18 dB)

Results of this test confidently shows high influence of DPSK channels, which disturb QAM channels. Hybrid coexistence of QAM and DPSK modulations have no chance to be used in optical networks due to high values of errors. DPSK channels do not "sense" adjacent channels. Dominance of DPSK channels in this and previous tests could be suppressed by tuning channel bandwidth and source laser power.

### 5.2.3 QAM/NRZ-OOK

Sixteen QAM channels each of 40 Gb/s and 16 NRZ-OOK channels each of 40 Gb/s, are transmitted over 50 km (25 km per span, 2 spans) of SSMF fiber. All channels are spaced at 200 GHz on wavelength bands recommended by ITU-T for DWDM systems. The signals are amplified by an EDFA booster and transmitted over optical amplified

link. Fiber dispersion is compensated after each in-line EDFA using parts of ideal fiber grating. At the receiver side three channels of NRZ-OOK modulation and 3 channels QAM are studied.

QAM

- 16x40 Gb/s channels with 200 GHz spacing - 1538.072 nm -1561.866 nm

NRZ-OOK

- 16x40 Gb/s channels with 200 GHz spacing - 1538.861 nm -1562.929 nm

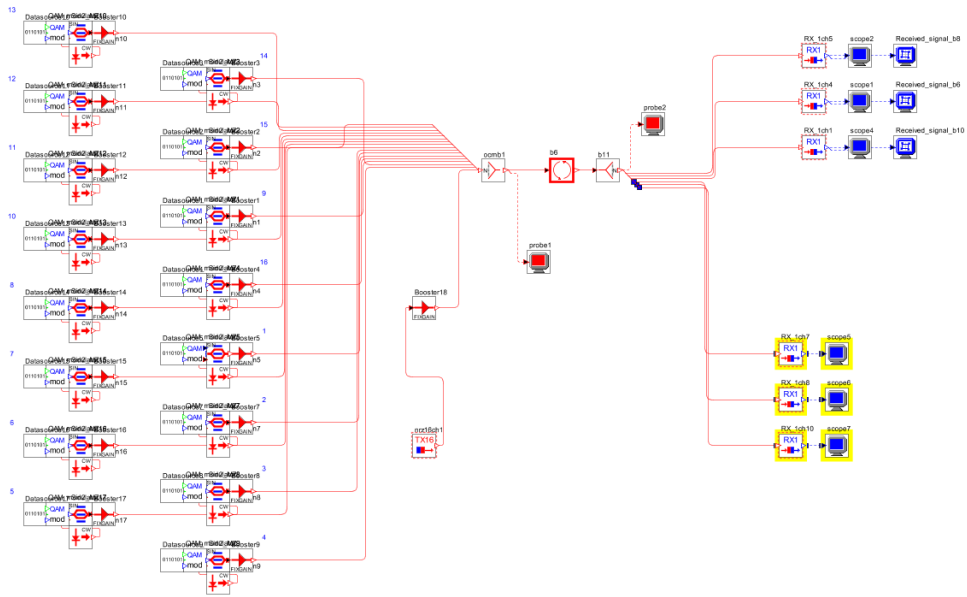

Figure 5.20: 16 channels QAM and 16 channels NRZ-OOK hybrid topology of DWDM system

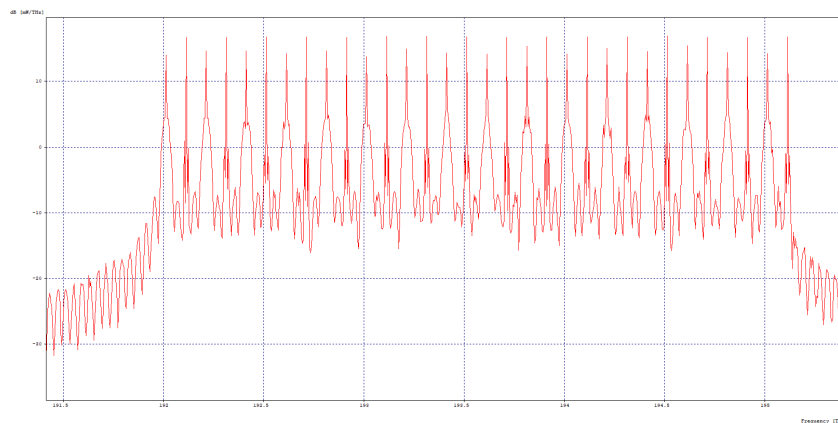

Figure 5.21: 16 QAM and 16 NRZ-OOK hybrid systems optical spectrum

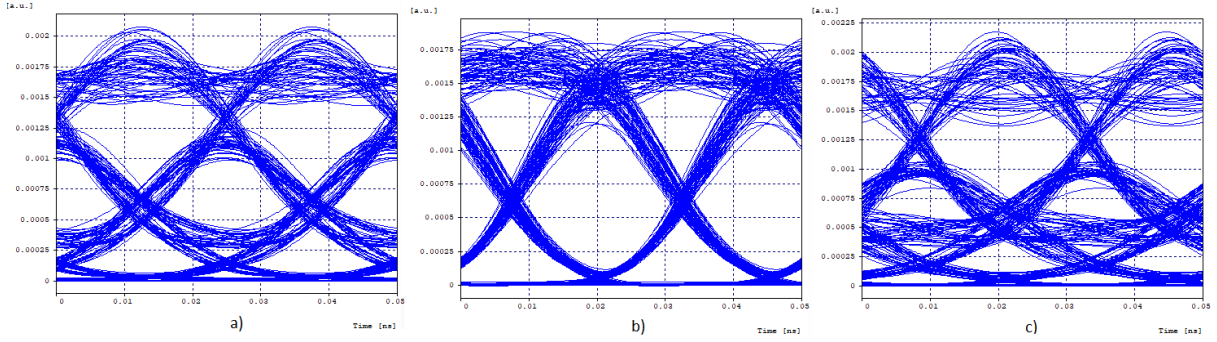

Figure 5.22: Eye diagrams a)channel 1 NRZ-OOK b)channel 7 NRZ-OOK c)channel 16 NRZ-OOK

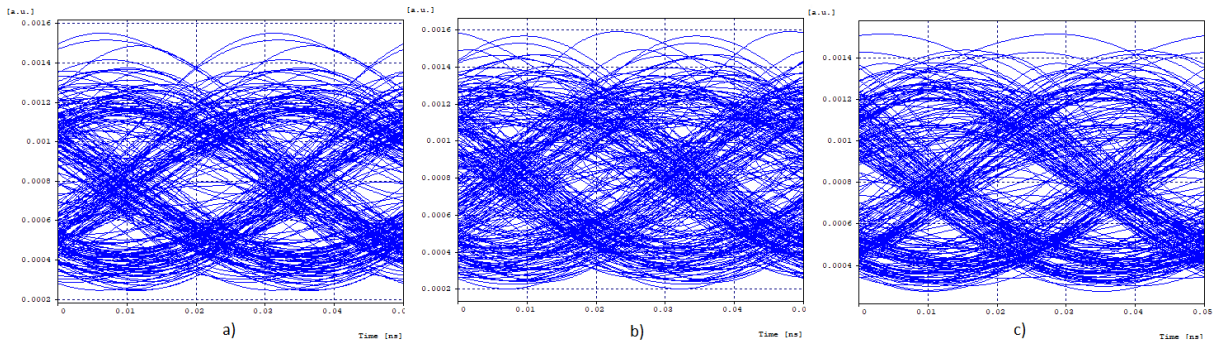

Figure 5.23: Eye diagrams a)channel 1 QAM b)channel 7 QAM c)channel 16 QAM

Table 5.6: Performance of evaluation criteria of QAM and NRZ-OOK DWDM systems

Channel	BER	Q-factor
Channel 1 QAM	$3.29 \cdot 10^{-3}$	2.72 (8.74 dB)
Channel 7 QAM	$1.03 \cdot 10^{-2}$	2.31 (7.26 dB)
Channel 16 QAM	$6.59 \cdot 10^{-3}$	2.66 (8.37 dB)
Channel 1 NRZ-OOK	$7.11 \cdot 10^{-5}$	3.82 (11.65 dB)
Channel 7 NRZ-OOK	$6.87 \cdot 10^{-23}$	10.06 (20.02 dB)
Channel 16 NRZ-OOK	$5.51 \cdot 10^{-3}$	2.55 (8.15 dB)

As can be seen from the test results, both modulations have a strong effect on each other. From this we can conclude that the implementation of NRZ-OOK and QAM channels with a separation of 100 GHz is a bad use case for optical systems. The impact of nonlinearities such as FWM and SPM in this case are critical for the stable transmission of information in the optical system. The impact on QAM channels destroys the channels eye diagram, which can be seen in the output. Eye diagram of NRZ-OOK channels is highly modified and looks more like DPSK. Furthermore NRZ-OOK channels closer to the center reduce the number of errors and in the center reach a significant BER value. This is a direct proof of the impact of FWM on channel quality.

### 5.2.4 Consequences

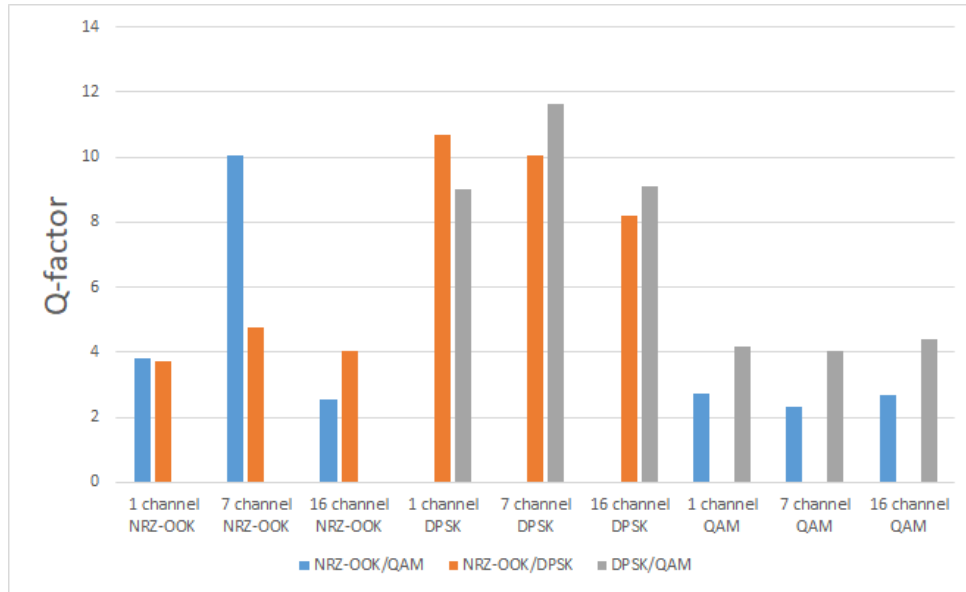

Figure 5.24: Comparison of Q-factor of DWDM systems

The test results showed that the assumptions about the unsatisfactory nature of this method of coexistence of systems turned out to be true. The Q-factor of DWDM channels with DPSK modulation suppressed the rest of the signals. Reducing the bandwidth of channels with this modulation has led to a sharp increase in noise in all channels. QAM and NRZ-OOK channels, as expected, could not reach the minimum Q-factor criterion of 6 units due to the strong influence of the channels on each other[23]. The influence of SPM was also noted, along with the already anticipated multichannel nonlinearities and FWM.

Based on this, I can confidently note that this method of coexistence of these systems cannot be implemented within the specified parameters.

## 5.3 DWDM/DWDM with safety band

In this section, the last possible way of coexisting DWDM systems is studied. This coexistence of DWDM systems on a safe distance from each other. This method is the best use of the width of the wavelength band, although DWDM systems in this case take up more space. DWDM channels with two different modulations located in the Conventional and Short bands are separated from each other by the space that separates them. It is assumed that this method will limit the effect of channels with different modulations from each other. Therefore, the results on the receiving side should roughly coincide with the results of the previous chapter.[25] The only thing that can affect the channels is



the inaccurate distribution of channels in the optical spectrum described in the ITU-T recommendations, which leads to linear channel effects.

### 5.3.1 DPSK/NRZ-OOK

DPSK channels each of 40 Gb/s are separated for safety band from NRZ-OOK channels each of 40 Gb/s. Distance of transmission used SSMF fiber is 50 kilometers. Signals are compensated by in-line EDFA using parts of ideal fiber grating. Safe space is over 2 nm. All channels are spaced at 100 GHz on wavelength bands recommended by ITU-T for DWDM systems. At the receiver side three channels of NRZ-OOK modulation and 3 channels DPSK are analyzed and compared.

DPSK

- 16x40 Gb/s channels with 200 GHz spacing - 1533.858 nm -1545.72 nm

NRZ-OOK

- 16x40 Gb/s channels with 200 GHz spacing - 1547.316 nm -1559.389 nm

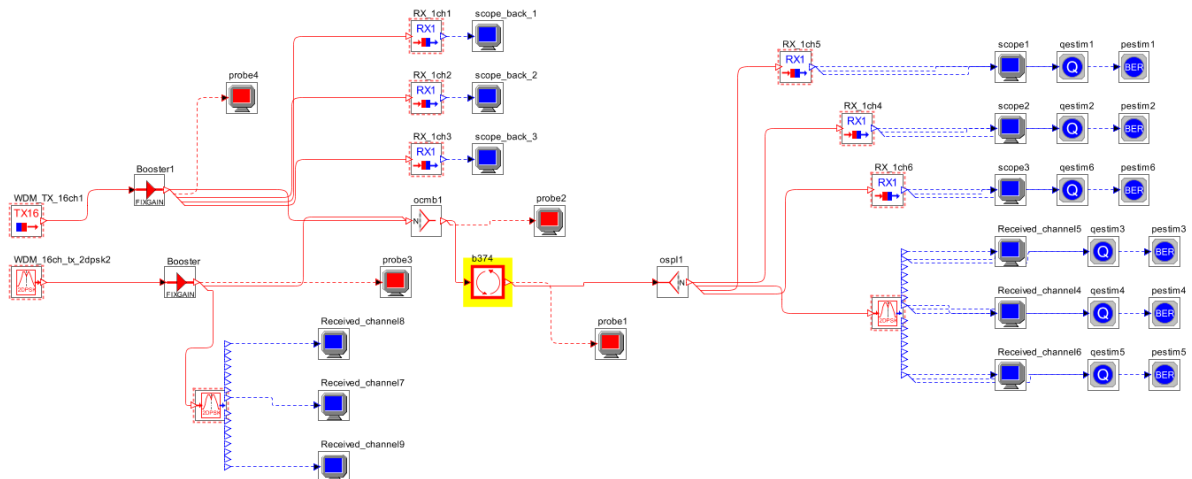

Figure 5.25: 16 channels DPSK and 16 channels NRZ-OOK topology of spaced DWDM system

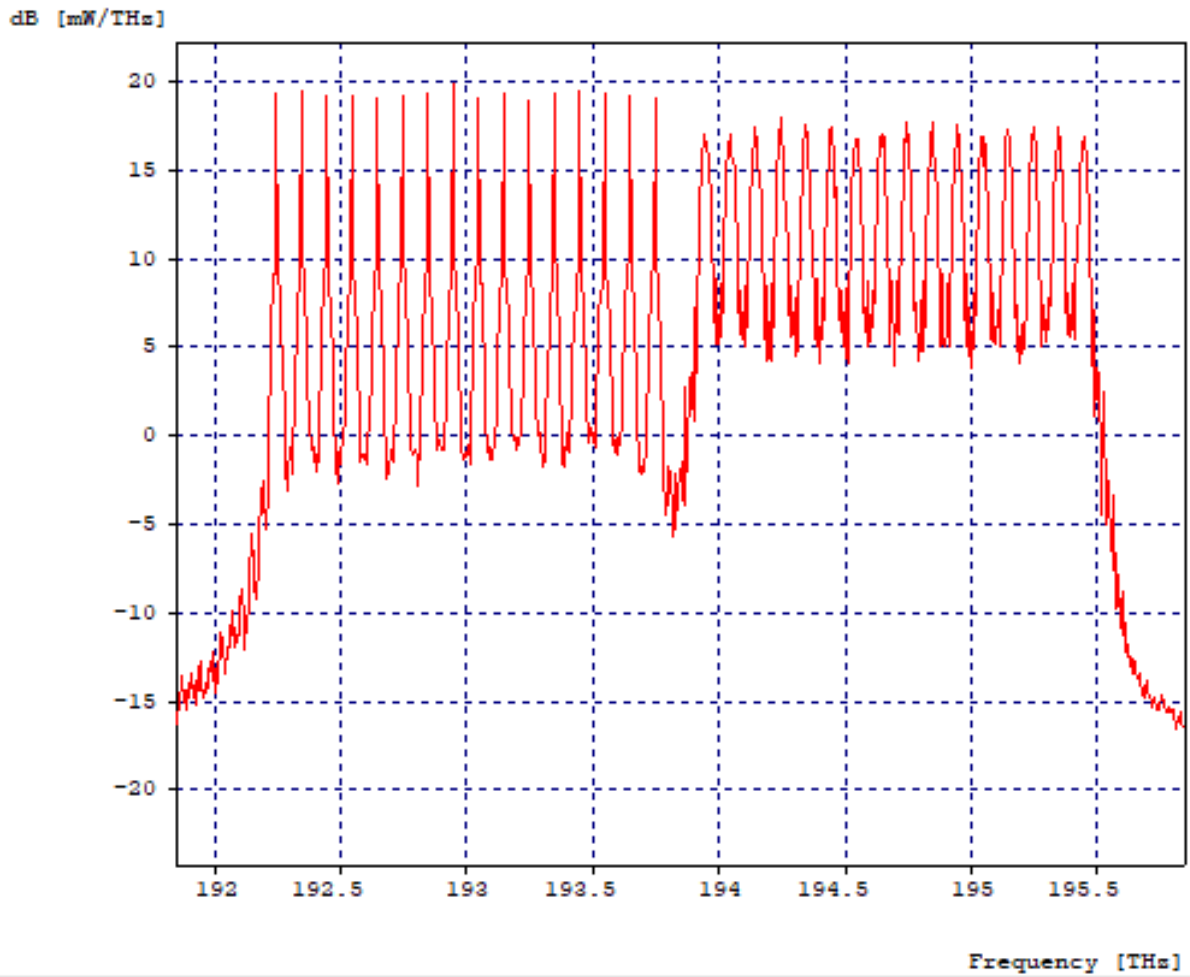

Figure 5.26: 16 QAM and 16 NRZ-OOK hybrid systems optical spectrum

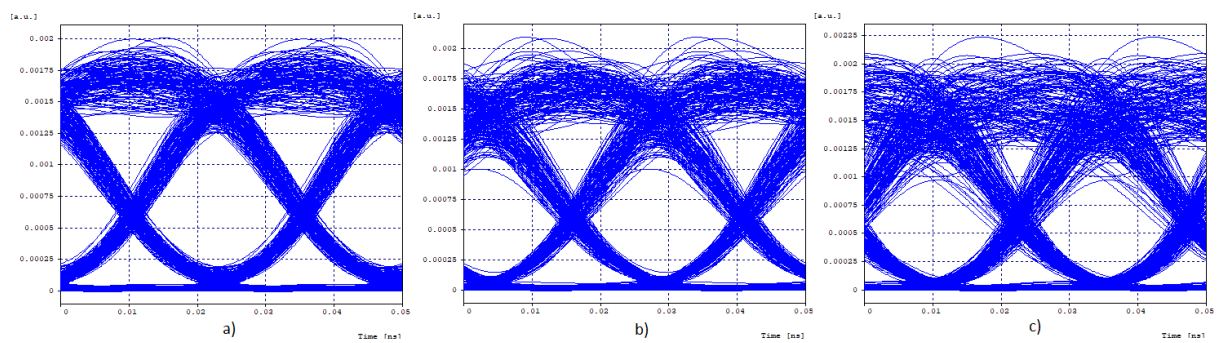

Figure 5.27: Eye diagrams a)channel 1 NRZ-OOK b)channel 7 NRZ-OOK c)channel 16 NRZ-OOK

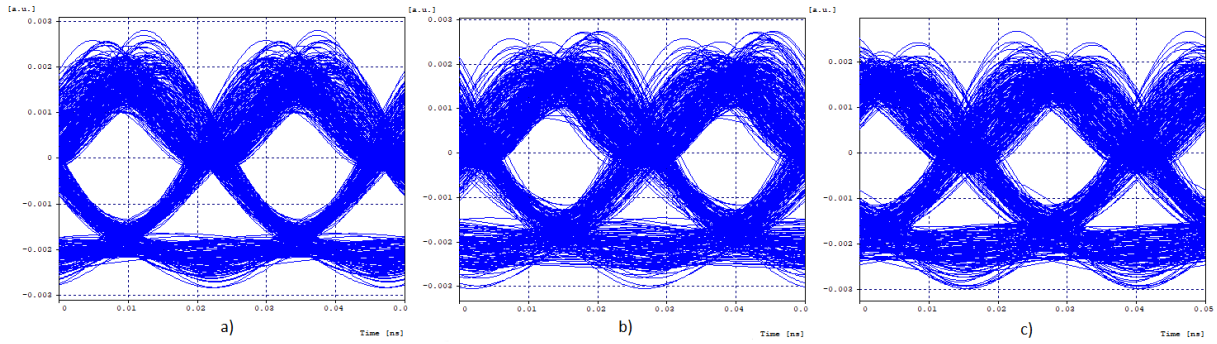

Figure 5.28: Eye diagrams a)channel 1 DPSK b)channel 7 DPSK c)channel 16 DPSK

Table 5.7: Performance of evaluation criteria of DPSK and NRZ-OOK DWDM systems with safety band

Channel	BER	Q-factor
Channel 1 DPSK	$3.02 \cdot 10^{-11}$	6.69 (16.51 dB)
Channel 7 DPSK	$6.48 \cdot 10^{-9}$	5.85 (15.34 dB)
Channel 16 DPSK	$2.17 \cdot 10^{-10}$	6.43 (16.18 dB)
Channel 1 NRZ-OOK	$1.11 \cdot 10^{-22}$	10.02 (20.02 dB)
Channel 7 NRZ-OOK	$1.62 \cdot 10^{-14}$	7.61 (17.63 dB)
Channel 16 NRZ-OOK	$3.91 \cdot 10^{-10}$	6.09 (15.71 dB)

As a result of the tests, it turned out that the channels with both modulations show results similar to the results on the receiving side separately for each of the modulations. Small changes are associated with the distribution of channels in the optical spectrum. In general, transmission quality, BER and Q-factor are sufficient for high-quality information transfer.

### 5.3.2 DPSK/QAM

DPSK channels each of 40 Gb/s are separated for safety band from QAM channels each of 40 Gb/s. Distance of transmission used SSMF fiber is 50 kilometers. Signals are compensated by in-line EDFA using parts of ideal fiber grating. safety band is over 2 nm. All channels are spaced at 100 GHz on wavelength bands recommended by ITU-T for DWDM systems. At the receiver side three channels of QAM modulation and 3 channels DPSK are analyzed and compared.

DPSK

- 16x40 Gb/s channels with 200 GHz spacing - 1547.2 nm -1559.271 nm

QAM

- 16x40 Gb/s channels with 200 GHz spacing - 1533.352 nm -1545.207 nm

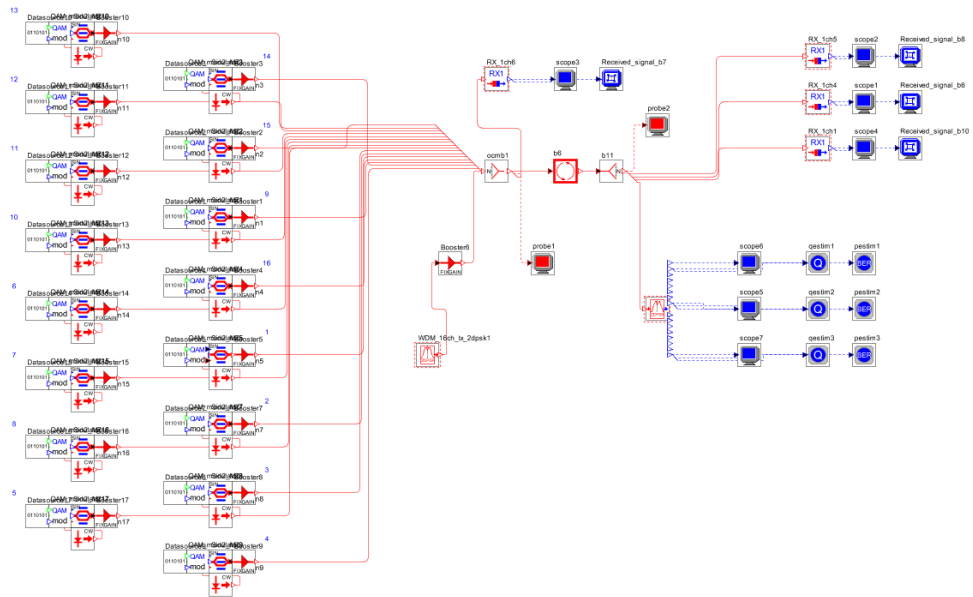

Figure 5.29: 16 channels DPSK and 16 channels QAM topology of spaced DWDM system

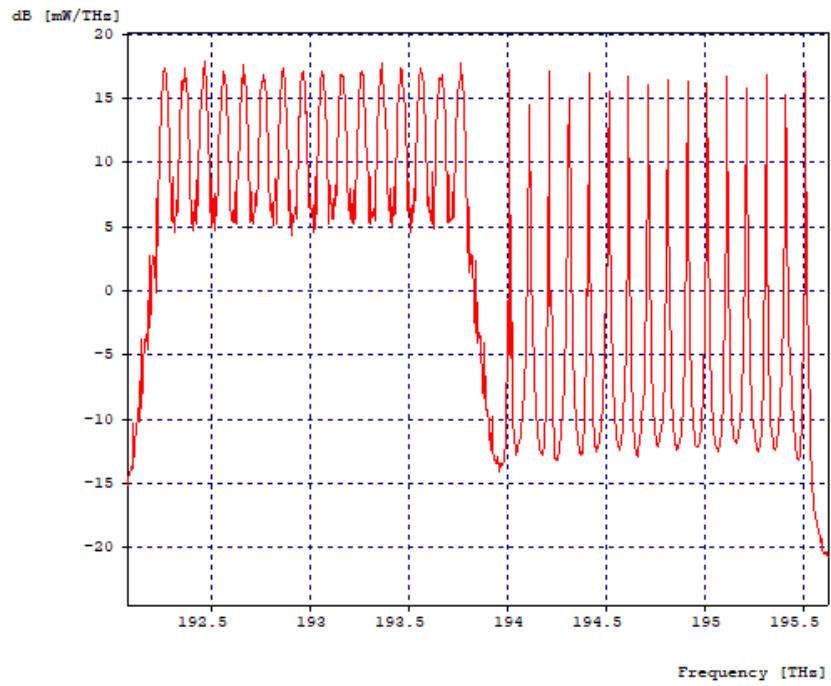

Figure 5.30: 16 QAM and 16 DPSK hybrid systems optical spectrum

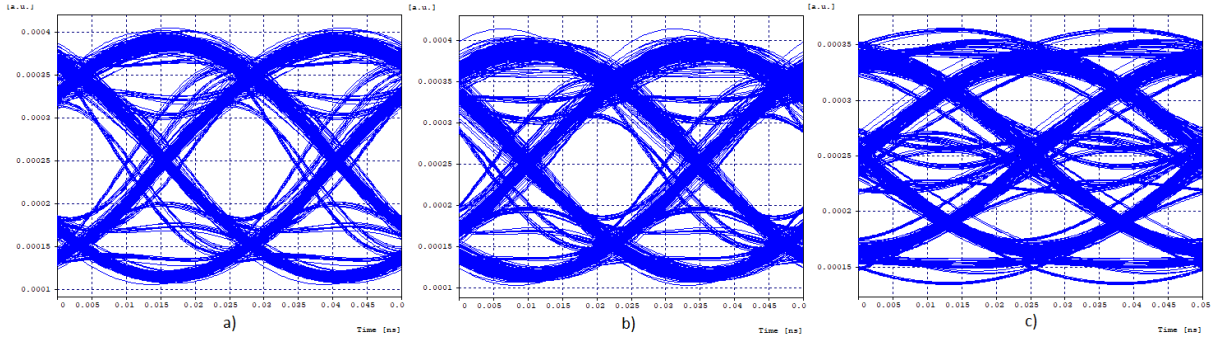

Figure 5.31: Eye diagrams a)channel 1 QAM b)channel 7 QAM c)channel 16 QAM

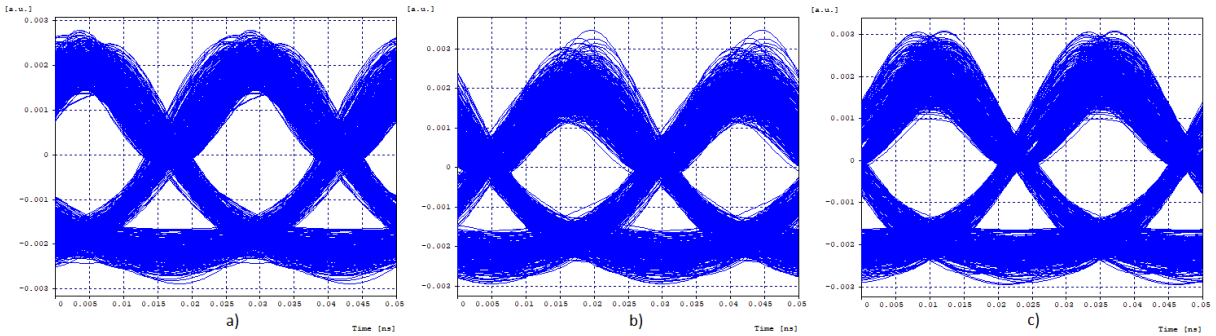

Figure 5.32: Eye diagrams a)channel 1 DPSK b)channel 7 DPSK c)channel 16 DPSK

Table 5.8: Performance of evaluation criteria of DPSK and NRZ-OOK DWDM systems with safety band

Channel	BER	Q-factor
Channel 1 DPSK	$4.32 \cdot 10^{-16}$	8.27 (18.35 dB)
Channel 7 DPSK	$5.65 \cdot 10^{-10}$	6.12 (15.73 dB)
Channel 16 DPSK	$9.77 \cdot 10^{-10}$	6.11 (15.71 dB)
Channel 1 QAM	$3.84 \cdot 10^{-38}$	12.95 (22.25 dB)
Channel 7 QAM	$3.84 \cdot 10^{-25}$	10.43 (20.37 dB)
Channel 16 QAM	$3.59 \cdot 10^{-7}$	5.01 (14.01 dB)

The coexistence of systems with these modulations is an exceptional example of how the mutual influence of channels on each other leads to an improvement in the performance of both. safety band, which was used to eliminate possible interference, significantly improved performance on the receiving side. This can be explained by the fact that non-linear phenomena that affect QAM-modulated channels have been suppressed by the DPSK channels in front of them. That is why the 16 channel QAM, less experiencing this phenomenon, shows the worst property.

### 5.3.3 QAM/NRZ-OOK

NRZ-OOK channels each of 40 Gb/s are separated for safety band from QAM channels each of 40 Gb/s. Distance of transmission used SSMF fiber is 50 kilometers. Signals are compensated by in-line EDFA using parts of ideal fiber grating. safety band is over 2 nm. All channels are spaced at 100 GHz on wavelength bands recommended by ITU-T for DWDM systems. At the receiver side three channels of NRZ-OOK modulation and 3 channels QAM are analyzed and compared.

NRZ-OOK

- 16x40 Gb/s channels with 200 GHz spacing - 1533.858 nm -1545.72 nm

QAM

- 16x40 Gb/s channels with 200 GHz spacing - 1547.316 nm -1559.389 nm

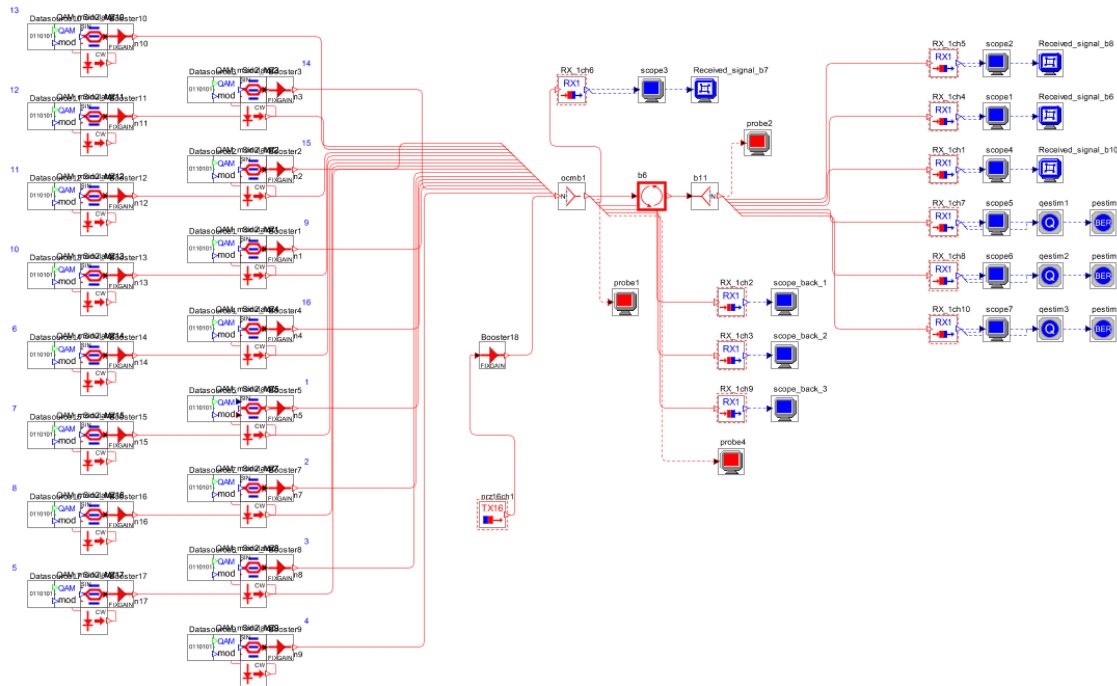

Figure 5.33: 16 channels NRZ-OOK and 16 channels QAM topology of spaced DWDM system

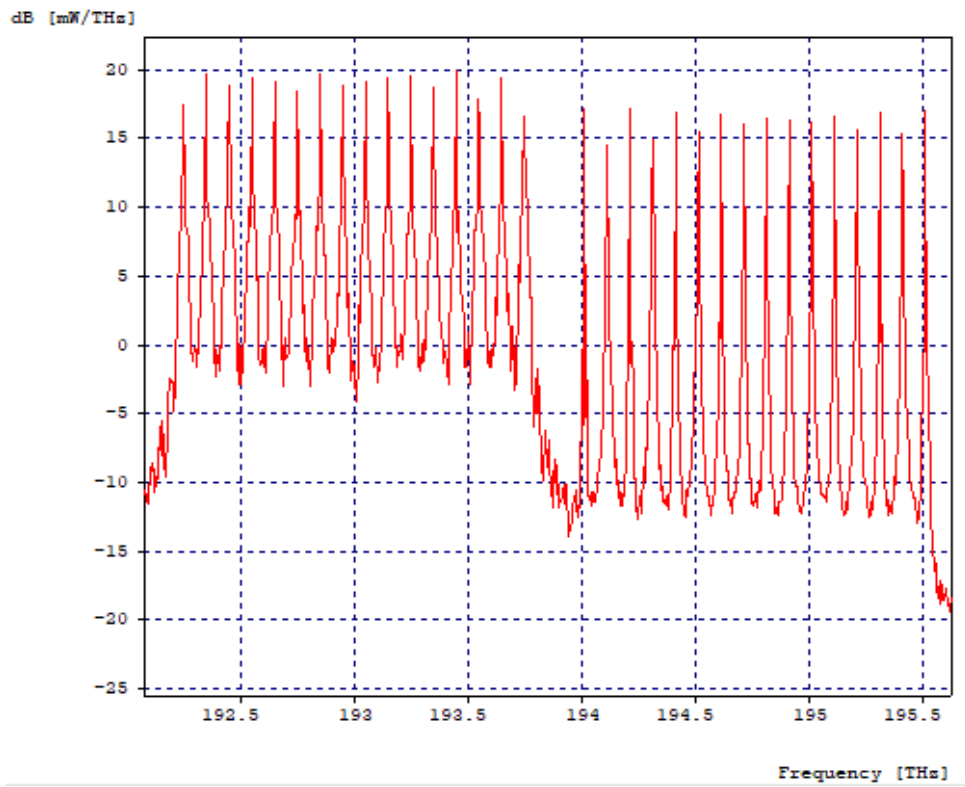

Figure 5.34: 16 QAM and 16 NRZ-OOK hybrid systems optical spectrum

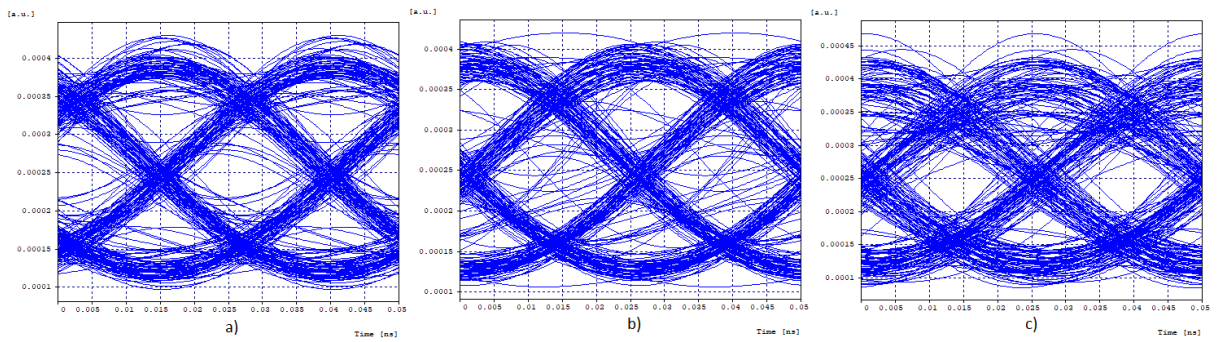

Figure 5.35: Eye diagrams a)channel 1 QAM b)channel 7 QAM c)channel 16 QAM

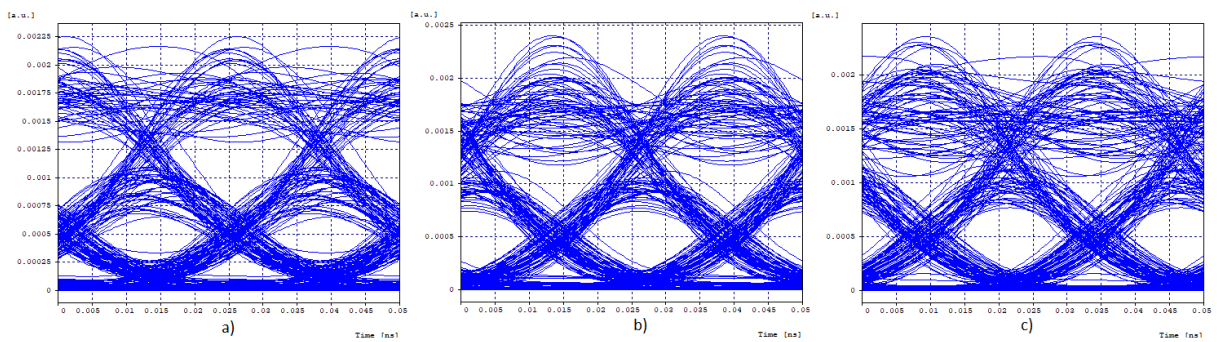

Figure 5.36: Eye diagrams a)channel 1 NRZ-OOK b)channel 7 NRZ-OOK c)channel 16 NRZ-OOK

Table 5.9: Performance of evaluation criteria of QAM and NRZ-OOK DWDM systems with safe space

Channel	BER	Q-factor
Channel 1 QAM	$7.52 \cdot 10^{-5}$	3.87 (11.76 dB)
Channel 7 QAM	$6.14 \cdot 10^{-7}$	4.91 (13.80 dB)
Channel 16 QAM	$1.94 \cdot 10^{-4}$	3.58 (11.08 dB)
Channel 1 NRZ-OOK	$2.66 \cdot 10^{-5}$	4.03 (12.11 dB)
Channel 7 NRZ-OOK	$1.29 \cdot 10^{-14}$	7.67 (17.69 dB)
Channel 16 NRZ-OOK	$1.46 \cdot 10^{-14}$	7.56 (17.57 dB)

In this case, NRZ-OOK and QAM, even with the safe space, influence each other. It was also noticed that the choice of the position of the QAM channels in the optical band strongly influenced the linear phenomena on the results on the receiving side. The results of the NRZ-OOK channel transmission are comparable to the results from the previous chapter. The first channel is strongly affected by the FWM caused by the QAM channels in front of them, as well as by the NRZ-OOK channels themselves. This way of existence of two modulations of DWDM systems is the worst one presented.

### 5.3.4 Consequences

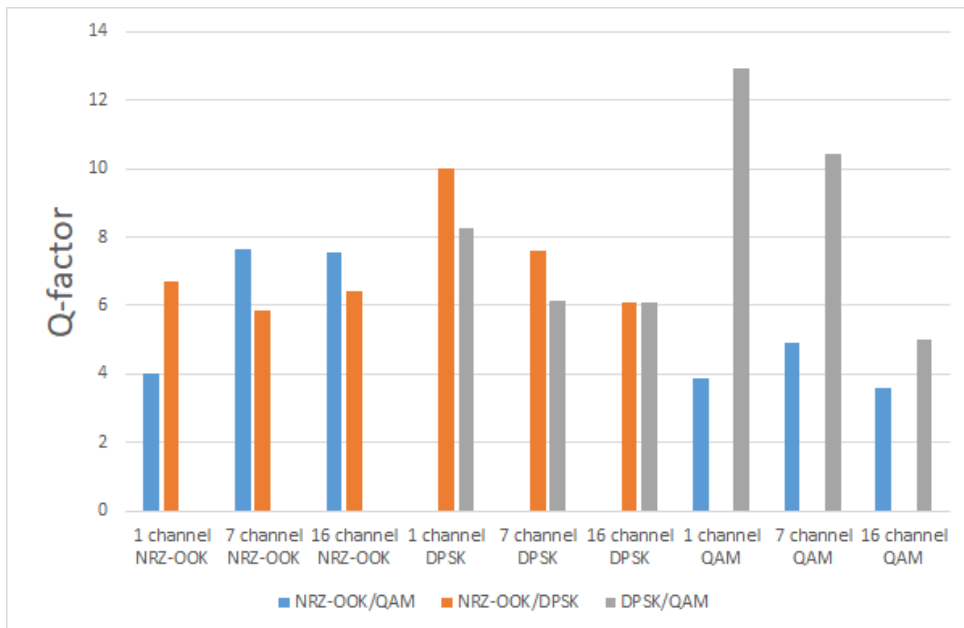

Figure 5.37: Comparison of Q-factor of DWDM systems

The test results showed that the effectiveness of this method of existence of two DWDM



systems on the same physical layer is better than the method of implementing systems into each other. In the case of NRZ-OOK and DPSK modulation, the safety band has limited the system exposure to each other. When using NRZ-OOK and QAM modulations, safety band did not limit the impact on the nearest channels, which are strongly influenced by nonlinearities, which should have been suppressed by this method. Also, the choice of wavelength band is one of the criteria when planning DWDM systems. A remarkable discovery is the coexistence of DPSK and QAM modulations, which leads to a dramatic improvement in the output of QAM and DPSK.

# Chapter 6

## Conclusion

In this thesis, WDM systems were studied for use in different situations. The main thing was to analyze possible scenarios of coexistence of systems with different modulations. When working on the thesis, the theoretical limitations and advantages of WDM systems were confirmed, namely, the coexistence of CWDM and DWDM systems, the implementation of channels with different modulations of DWDM systems, and the coexistence of systems in DWDM with different modulations with safety band.

The parameters that were set for all tests limited the possible achievements of each of the modulations. This was done intentionally to show the limits of these modulations and systems. Thus, the bit rate of DWDM systems was chosen at 40 Gb / s and channel spacing was chosen at 100 GHz, which significantly affects the output of channels of all modulations. The CWDM system bit rate, which was selected as the maximum for this system, did not affect the output results due to ideal software environment.

The main conclusions that can be drawn from each experiment:

Modulations

- NRZ-OOK modulation is strongly influenced by FWM and cross-channel interference due to high bit rate.
- DPSK output errors are caused by narrow-band filtering leads to warp phase relations between the neighboring bits.
- QAM modulation is very sensitive to fiber parameters. Small increases of bit rate instantly influence BER by thousands points.
- Influence of dispersion can be suppressed by using Non-Zero Disperse-Shifted Fibers (NZDSF), shifted closer to 1550 nm band wavelengths

CWDM over DWDM

- S CWDM channels do not quite correspond to the real indicator of these systems. As already noted, the CWDM channels have no errors due to ideal software environment.
- Indicators of QAM modulation are one of the problems that it turned out to be

solved by reducing the bit rate of the channels.

- channels with DPSK modulation showed sufficient level of quality.
- NRZ-OOK DWDM channel modulation showed the highest results.
- In order to reduce the number of data transmission errors of systems, need to use fiber with a shifted non-zero dispersion. This may affect the quality of channels that are closer to the E band, but will significantly suppress the effect of dispersions on DWDM channels.

DWDM/DWDM implemented

- The Q-factor of DWDM channels with DPSK modulation suppressed the rest of the channels.
- Reducing the bandwidth of channels with this modulation has led to a sharp increase in noise in all channels.
- QAM and NRZ-OOK channels could not reach the minimum Q-factor criterion of 6 units due to the strong influence of the channels on each other. The influence of SPM was also noted, along with the already anticipated multichannel nonlinearities and FWM.
- Based on this, I can confidently note that this method of coexistence of these systems cannot be implemented within the specified parameters.

DWDM/DWDM with safety band

- The test results showed the effectiveness of this method .
- The safety band has limited the system exposure to each other of NRZ-OOK and DPSK modulation. · The choice of wavelength band is one of the important criteria for planning DWDM systems. · Coexistence of DPSK and QAM modulations leads to a dramatic improvement in the output results of QAM and DPSK channels

The main advantage of this thesis is a detailed study of the use of coexistence of DWDM systems in an environment that is as close to real as possible. This work points out the possible difficulties of implementing DWDM systems into existing ones, and can also help in choosing optical technologies and systems for further use presented in this work.

# Chapter 7

## References

- [1] ITU-T Recommendation ITU-T G.694.2, "Spectral grids for WDM applications: CWDM frequency grid.", 2012
- [2] ITU-T G.695 Recommendation ITU-T G.695 "Optical interfaces for coarse wavelength division multiplexing applications", 2018
- [3] ITU-T Recommendation ITU-T G.694.1, "Spectral grids for WDM applications: DWDM frequency grid.", 2012
- [4] ITU-T Recommendation ITU-T G.652 , "Characteristics of a single-mode optical fibre and cable", 2016
- [5].V. ERZEN, B. BATAGELJ. "NG-PON1: technology presentation, implementation in practice and coexistence with the GPON system". Electrotechnical Review. 79(3): pp. 117-122, 2012
- [6] J. VODRÁŽKA "Optické přístupové sítě EPON a CWDM". In Prague: Czech Technical University 2005 Available from < <http://access.feld.cvut.cz/view.php?cisloclanku=2005070401> > .
- [7] L. BOHÁČ, M. LUCKI "Optické komunikační systémy". Vol. 1. In Prague: Czech Technical University, 2010.
- [8] H. SUZUKI, M. FUJIWARA, N. YOSHIMOTO, H. KIMURA, K. KUMOZAKI. "Simplified Wavelength-Tunable DWDM Selector using Removable Driving Circuit for Coexistence-Type WDM-PON". 35th European Conference on Optical Communication, Vienna, Austria, 2009
- [9] A. HODZIC "Investigations of high bit rate optical transmission systems employing a channel data rate of 40 Gb/s". Doctoral Thesis. Technischen Universität Berlin , 2004
- [10] S. D. PERSONIC. "Receiver design for digital fiber optic communications systems". Bell System Technology Journal, 52(6), 1973.
- [11] K. O. HILL, D. C. JOHNSON, B. S. KAWASAKI, R. I. MACDONALD. "CW three-wave mixing in single-mode optical fibers". Journal of Applied Physics, 49(10), pp.

5098–5106, 1978.

[12] G. P. AGRAWAL. “Nonlinear Fiber Optics”. Number ISBN 0-12-045143-3. Academic Press, 3 edition, 2001.

[13] E. DESURVIRE, D.BAYART, B. DESTHIEUX, S. BIGO. “Erbium-doped Fiber Amplifiers - Device and System Developments”. Number ISBN 0-471-41903-6. A John Wiley and Sons, Inc., Publication, 2002.

[14] ITU-T Telecommunication standardization sector of ITU. ITU-T G.692: “Optical interfaces for multichannel systems with optical amplifiers”, 1998.

[15] F. SHIMIZU, “Frequency broadening in liquids by a short light pulse”, *Phys. Rev. Lett.* 19 (19),p.1097, 1967

[16] A. VANDERKA, L. HAJEK, J. LATAL, J. VITASEK, P. KOUDELKA, ”Design, Simulation and Testing of the OOK NRZ Modulation Format for Free Space Optic Communication in a Simulation Box”. *OPTICS AND OPTOELECTRONICS*, VOL. 12, No. 6, 2014

[17] T. WUTH , M. W. CHBAT, V.F. KAMALOV ”Multi-rate (100G/40G/10G) Transport Over Deployed Optical Networks”. Conference on Optical Fiber Communication/National Fiber Optic Engineers Conference. IEEE, 2008

[18] T. SABAPATHI, S. SUNDARAVADIVELU. “Analysis of Bottlenecks in DWDM Fiber Optic Communication System”. *Optik-International Journal for Light and Electron Optics*, Vol. 122, No. 16, pp. 1453-1457, 2010.

[19] F. HEISMANN, P. MAMYSHEV.”43-Gb/s NRZ-PDPSK WDM Transmission with 50 GHz Channel Spacing in Systems with Cascaded Wavelength-Selective Switches”. *Optical Fiber Communication Conference and National Fiber Optic Engineers Conference. IEEE*, 2009

[20] V. BOBROVS, J. PORINS, G. IVANOV. “Influence of Nonlinear Optical Effects on the NRZ and RZ Modulation Signals in WDM Systems“. *ELECTRONICS AND ELECTRICAL ENGINEERING*. Number ISSN 1392 – 1215. No. 4(76), 2007

[21] F. TOSCO. ”Fiber optic communications handbook”. TAB Professional and Reference Books, 1990

[22] M. WU, W.I. WAY. ”Fiber Nonlinearity Limitations in Ultra-Dense WDM Systems”. *Journal of Lightwave Technology*,Vol.22 , Is. 6, Number ISDN 1558-2213 IEEE, 2004

[23] RSOFT DESIGN GROUP, INC. *OptSim User Guide*, 2010.

[24] ITU-T. ”Optical fibres, cables and systems”. Geneva: International Telecommunication Union, 2009.

[25] M.C. KAPSE, S.S. SRIRAMWAR. ”Study of development of 40 Gb/s DWDM systems over existing 10 Gb/s DWDM systems”. *Journal of Data Mining and Knowledge*

Discovery. Number ISSN 2229–6662, Vol. 3, Is. 1, 2012, pp.45-48, Indie, 2012.

[26] S. SHARMA, V. SHARMA, D. KAUR. "REVIEW PAPER ON DWDM TECHNOLOGY". European Scientific Journal. Number ISSN 1857 – 7881, Vol.2, 2015

[27] A. BASAK, Z. TALUKDER, R. ISLAM. "Performance Analysis and Comparison between Coarse WDM and Dense WDM". Global Journal of Researches in Engineering Electrical and Electronics Engineering. Number ISSN: 2249-4596. Vol. 13 Is. 6, 2013

[28] Y. HOTTA, A. TSUJI, K. SUGIMURA, S. KOZAKI, N. SUZUKI, J. NAKAGAWA, K. SHIMOKASA. "The Demonstration of Symmetric 10G-EPON System for Coexistence with 1G-EPON". Conference on Optical Fiber Communication, San Diego, CA, USA, 2009

[29] X. LIU , O. BERTRAN , J. RENAUDIER , H. MARDOYAN , P. TRAN , G. CHARLET, S. BIGO. "Can 40-gb/s duobinary signals be carried over transparent DWDM systems with 50-GHz channel spacing?". IEEE Photonics Technology Letters. Number ISSN 1941-0174. Vol. 17 , Is. 6. IEEE, 2005

[30] S. SUGURMAN, P. VAMSY NATH REDDY, S. VAMSY NATH REDDY. "Design of WDM Optical Networks for the Analysis of Cross Phase Modulation and Self Phase Modulation". Global Trends in Computing and Communication Systems. ObCom 2011. Number ISSN 978-3-642-29219-4. Communications in Computer and Information Science, Vol. 269. pp. 370-379. Springer, Berlin, Heidelberg, 2012